



**TRAX**

**Intelligent Pipeline  
Technology**

## **4000SD Operating Manual**

Subsea Magnetic Pig Signaller



# CONTENTS

Page

1.	GENERAL DESCRIPTION .....	2
2.	TYPICAL SPECIFICATIONS .....	3
3.	RULES FOR SAFE OPERATION .....	4
4.	OPERATION .....	5
4.1.	TURNING ON.....	5
4.2.	STABILISATION.....	6
4.3.	LISTENING .....	6
4.4.	DETECTION MODES .....	7
4.4.1.	PIG DETECT MODE.....	7
4.4.2.	PIG PASS MODE .....	8
4.5.	DETECTION DELAY .....	9
4.5.1.	DEBUG MODE.....	9
4.5.2.	LATCHED DETECTION DELAY.....	9
4.6.	LOG MEMORY .....	9
4.7.	SURVEY MODE .....	10
4.8.	SINGLE BUTTON MENU INTERFACE.....	10
4.8.1.	EXIT.....	11
4.8.2.	STATUS.....	11
4.8.3.	VIEW EVENTS .....	11
4.8.4.	DELETE ALL EVENTS .....	11
4.8.5.	SHUTDOWN .....	12
4.8.6.	MORE.....	12
4.8.7.	SET DETECTION DELAY / STABILISATION DELAY.....	12
4.8.8.	POWER MODE .....	12
4.8.9.	SET THRESHOLD .....	12
4.8.10.	SET DATE / TIME .....	12
4.8.11.	SET DETCT CRITERIA .....	12
4.8.12.	SET SURVEY TIME.....	13
4.9.	RAM MEMORY ERROR.....	13
4.10.	SWITCH ACTIVATED MESSAGE.....	13
4.11.	BATTERY LIFETIME AND REPLACEMENT.....	14
4.12.	EXTERNAL CONNECTIONS .....	15
4.13.	ROV SWITCH OPTION .....	15
4.14.	INTERFACE OPTIONS .....	15
5.	DEPLOYMENT .....	16
5.1.	MOUNTING .....	17
5.2.	RECOMMENDED MAGNET ARRANGEMENT .....	18
6.	SOFTWARE .....	19
6.1.	SOFTWARE CONNECTION AND DATA UNLOAD.....	21
6.2.	SOFTWARE INSTALLATION .....	22
6.2.1.	MICROSOFT .NET FRAMEWORK INSTALLATION .....	22
6.2.2.	4000SD SOFTWARE INSTALLATION .....	22
6.2.3.	USB-RS232 DRIVER INSTALLATION .....	22
7.	MAINTENANCE AND STORAGE.....	23
7.1.	O-RING REPLACEMENT.....	23
7.2.	CABLES / CONNECTORS .....	24
7.2.1.	CONNECTOR ENGAGEMENT (MATING).....	24
7.2.2.	CONNECTOR DISENGAGEMENT (UNMATING) .....	24
7.2.3.	CONNECTOR CLEANING AND RE-USE .....	24
7.2.4.	CONNECTOR INSPECTION.....	25
8.	DISPOSAL OF UNIT .....	26
9.	WARRANTY .....	26

# 1. GENERAL DESCRIPTION

The 4000SD magnetic pig signaller is a compact, self-contained, non-intrusive, magnetic pig signaller suitable for harsh subsea applications. The 4000SD detects, logs, and signals (via the display and LEDs) the passage of magnetic pigs at the point of installation on a pipeline. The unit can log the time and date of up to 99 pig passages. This logged information can be viewed at any point using the integrated, high visibility, OLED display. The user can turn the unit ON and OFF as well as modify several settings using the single control button and intuitive menu system.

The unit is suitable for use on pipelines with wall thickness in excess of 40mm. Detection speed ranges from 0.1 to greater than 20 metres per second. Window of detection is typically 0.5m either side of the unit. The detection capabilities vary depending on the background magnetic noise, pig speed, pipeline diameter, wall thickness and the quality of magnets fitted. It is recommended that pigs are fitted with rare earth magnets (neodymium iron boron) to maximise magnetic signal.

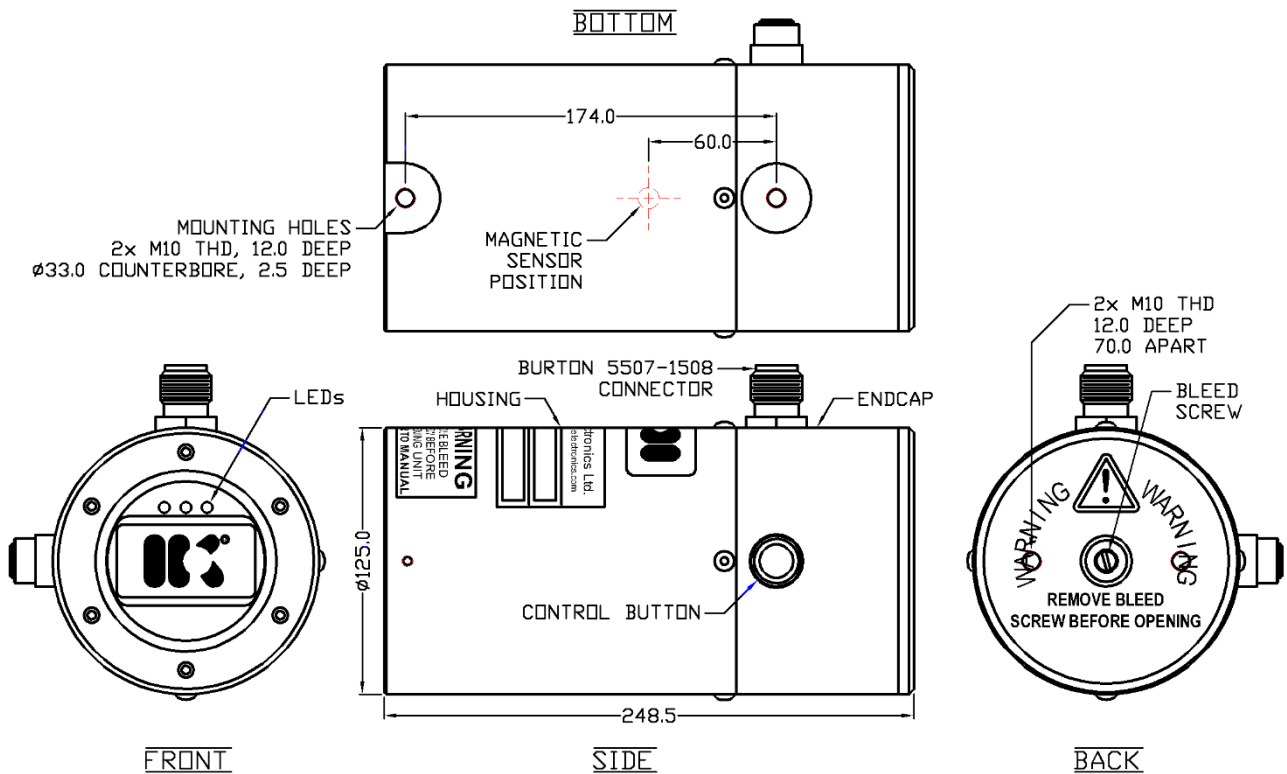

**DIGITAL INTERFACE OPTIONS:** The unit can be interfaced with a standard acoustic transmitter, strobe, or other equipment to remotely signal the passage of a pig.

**ACOUSTIC DATA TRANSDUCER INTERFACE OPTION:** The unit can be interfaced with an acoustic data transducer. This allows data to be monitored every minute or more at a range of up to 10km.

**ROV CONTROL OPTION:** The unit can be provided with a robust, ROV manipulated switch which provides the same functionality as the standard, single control button.

**MOUNTING OPTION:** The unit may be supplied with a rugged BASE PLATE which can be strapped onto the pipeline or with a custom cradle specified by the client for ease of deployment. The unit is always supplied with 2x M10 threaded holes 174mm apart as shown above.

## 2. TYPICAL SPECIFICATIONS

### GENERAL:

Battery life SIGNALLING in STANDARD POWER MODE at +0°C.....	30 days
Battery life LISTENING in STANDARD POWER MODE at +0°C.....	36 days
Battery life in LISTENING in LOW POWER MODE at +0°C.....	110 days
Battery type .....	10.5V Alkaline pack
Operating temperature range.....	-5°C to +70°C
Water Depth rating .....	3000m
Logging capacity .....	99 events
Weight in air .....	13kg
Pig Speed Range .....	0.01m/s to 20m/s

### MATERIALS:

Housing material .....	ALLOY BRONZE CA104 EN 12163
Endcap material .....	ALLOY BRONZE CA104 EN 12163
Bleedscrew material.....	ALLOY BRONZE CA104 EN 12163
Window material .....	ACRYLIC
Endcap Orings.....	2x BS 50-243 NBR70 with 2x BS 250-243 PTFE BUR
Window Orings.....	1x BS 50-236 NBR70 and 1x BS 50-237 NBR70
Bleedscrew Oring .....	1x BS 50-008 NBR70

### OUTPUT OPTIONS:

Serial data communication.....	RS232
Remote communication .....	Acoustic data transducer
Relay outputs.....	DPDT, 30VDC @ 1.0A
Transistor open-collector output .....	30V, 0.1A
Switched voltage output.....	Battery Voltage (9V), 0.05A

### 3. RULES FOR SAFE OPERATION

**⚠ WARNING:** Any operation involving pressure is potentially hazardous. No person should use this equipment unless they are fully aware of the potential hazards of working with pressurised vessels. The purchaser of this equipment is responsible for the training and competence of operators and the manner in which it is used. This manual should be read through and understood before installation and commissioning so that the operator is familiar with the equipment. Contact IK Trax immediately should any difficulty arise in the use of this equipment.

**⚠ WARNING:** Always use caution when opening equipment that has been in a pressurised environment. It is possible for pressure to leak into the equipment and remain there even after external pressure has been removed. ALWAYS point the end to be opened towards a safe area and away from yourself or others. Contact IK TRax immediately if there is a suspicion that the equipment has become pressurised.

**⚠ WARNING:** Replace all batteries at the same time. NEVER install used batteries. NEVER install a mix of new and used batteries. Use only new batteries from the same package or manufacturing batch. DO NOT mix different brands or types of batteries. ALWAYS observe correct battery polarity. New batteries should be installed before each deployment.

**⚠ WARNING:** Do not expose to aggressive solvents or chemicals which could be harmful to the HOUSING, O-RINGS, CONNECTORS or any other parts of the equipment.

**⚠ CAUTION:** The equipment should only be opened in a clean laboratory environment.

**⚠ CAUTION:** To prevent the formation of condensation within the signaller, allow the signaller temperature to stabilise within the laboratory environment for a minimum of 6 hours prior to opening.

**⚠ CAUTION:** It is possible for liquids to become trapped in threads and/or gaps around openings. ALWAYS point the end to be opened downwards to allow any trapped liquid to drain out of and not into the equipment.

## 4. OPERATION

Before each and every deployment complete the checks outlined in section 5 DEPLOYMENT. Repeating these checks before each and every deployment will pick up most problems before the unit is deployed saving significant costs and avoiding unnecessary delays. If the results of any of these checks are not as expected, then please contact IK Trax immediately.

### 4.1. TURNING ON

To turn the unit on simply press and hold the control button until the IK logo is displayed and then release, this takes approximately 5 seconds.

If using the ROV switch, turn the ROV switch to the 'ON' position until the IK logo is displayed and then turn to the 'OFF' position, this takes approximately 5 seconds. Refer to section 4.13 ROV SWITCH OPTION if required.

The first screen to appear after switch on is the IK logo. This will be displayed for 5 seconds as shown by the COUNTDOWN INDICATOR located at the bottom left hand side of the display.

A battery level indicator is shown at the bottom right hand side of the display. This meter gives an indication of the remaining battery lifetime while at room temperature. When the COUNTDOWN INDICATOR reaches zero, or the CONTROL BUTTON is pressed, the next screen will appear.

The next screen shows the 4000SD logo, COUNTDOWN INDICATOR, firmware version, and BATTERY INDICATOR.

The next screen shows the current status of all parameters as per section 4.8.2 STATUS. When the COUNTDOWN INDICATOR reaches zero, or the CONTROL BUTTON is pressed, the next screen will appear.

The next screen shows the STABILISATION delay as per section 4.2 STABILISATION. Once the STABILISATION delay reaches zero or the CONTROL BUTTON is pressed, the unit will begin LISTENING as per section 4.3 LISTENING.

While LISTENING, the screen will show the live DIFFERENCE flux readings at the top of the display and the current number of events logged. If previous EVENTS have been logged then a graphical representation of the DIFFERENCE signal of the most recent event along with the date and time of the event, will be shown. The LEDs will flash every 30 seconds. See section 4.3 LISTENING for more information.

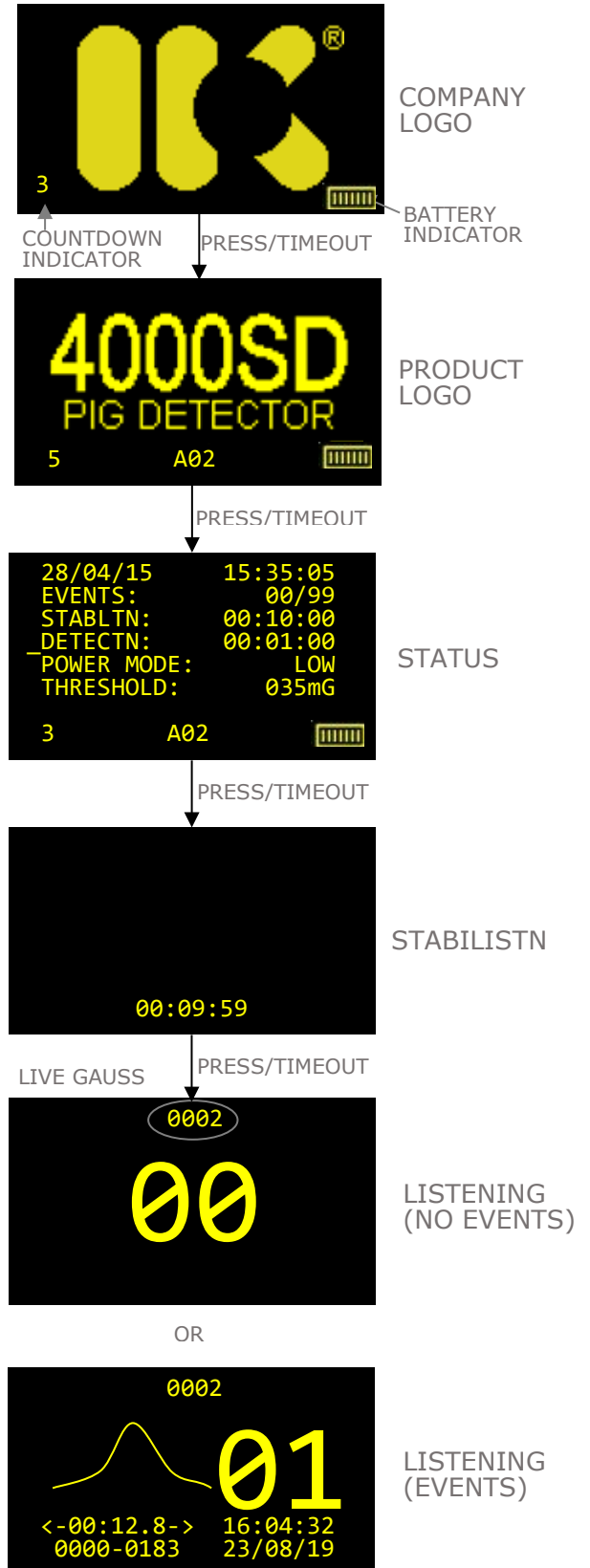

## 4.2. STABILISATION

The STABILISATION delay occurs when the unit is turned ON only. During STABILISATION the unit will not detect or log any magnetic events and the LEDs will flash every 30 seconds. The STABILISATION delay can be used during deployment to prevent any unwanted events from being logged due to movement of the unit in the earth's magnetic field and/or movement of magnetic objects (such as ROVs) nearby.

For example, if it is planned to turn the unit ON at 13:00 while on deck, immediately deploy subsea using an ROV over the following 3 hours, and then detect a pig passage expected at 17:00 then the STABILISATION delay can be set to 03:30:00 so that when the unit is turned ON at 13:00 the ROV has 3.5 hours to deploy the unit subsea and the unit will start LISTENING for a pig at 16:30.

In this example, if the STABILISATION delay was set to less than 03:00:00 then there is a very high risk that unit will be repeatedly triggered during deployment due to the ROV moving nearby or the unit itself moving in the earth's magnetic field.

The STABILISATION delay can be set to any value between 00:00:00 and 99:99:99 (in HH:MM:SS format) using the CONTROL BUTTON or using the 4000SD CONFIG software as per section 6 SOFTWARE. During the STABILISATION delay a countdown timer is displayed as shown. Once this timer reaches 00:00:00 or the CONTROL BUTTON is pressed the 4000SD will start LISTENING.

## 4.3. LISTENING

After STABILISATION the unit will start LISTENING and display something similar to the screen shown opposite. This screen shows listening mode with no event or listening showing the last EVENT recorded.

If no previous events have been detected yet then this screen will show a large '00' with no graph, date or time. The LEDs above the display will flash every 30 seconds.

If previous events have been detected then this screen will show a graphical representation of that event, large digit event number, time and date of the event, time span of the event and the peak difference. The example shows EVENT #01 occurred at 13:56:42 on 28/04/11, lasted for 12.8 seconds with a peak difference of 183mGauss.

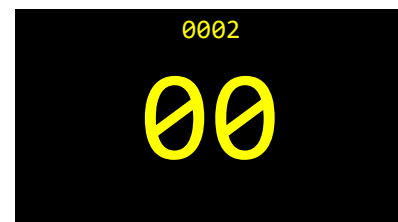

LISTENING - NO EVENTS



LISTENING - WITH EVENTS

The four digits at the top of these screens show the live DIFFERENCE gauss reading. In a magnetically quiet environment this number can be expected to flicker between 0000 and 0005. While LISTENING the unit continually measures RAW flux readings which are FILTERED and the DIFFERENCE between the RAW and FILTERED values are calculated and displayed. If the DIFFERENCE ever exceeds the THRESHOLD setting (see section 4.8.9 SET THRESHOLD) then the unit will enter DETECTION mode as per 4.4 DETECTION MODES. There are three things that may cause this screen to change:

**MAGNETIC EVENT** – If a DIFFERENCE greater than the THRESHOLD setting is detected while the unit is LISTENING, then the 4000SD will enter DETECTION mode as per 4.4 DETECTION MODES.

**LOW POWER MODE** – In STANDARD POWER MODE the display will be ON all of the time. In LOW POWER MODE, after 1 minute of inactivity, the display will turn OFF for 13 seconds every 15 seconds to preserve battery life. While in LOW POWER MODE a single press of the CONTROL BUTTON will turn the display ON for 1 minute. Note that while the display is OFF the 4000SD is

still LISTENING for a magnetic event. See section 4.8.8 POWER MODE. If a magnetic event is detected then the display will come on as normal and show DETECTION mode.

**CONTROL BUTTON** – Pressing the CONTROL BUTTON while the display is ON will enter the DISPLAY MENU interface which is described in section 4.8 SINGLE BUTTON MENU INTERFACE.

#### 4.4. DETECTION MODES

There are two possible detection modes described in the following sections depending on how the unit has been configured as per 4.8.11 SET DETCT CRITERIA.

##### 4.4.1. PIG DETECT MODE

PIG DETECT mode is used to detect the presence of pigs but does not attempt to confirm they have passed the signaller. This can be useful at pig launchers or receivers where depending on signaller position the pig may only move away from or approach a signaller without actually passing it.

PIG DETECT mode is basically the same as 4.4.2 PIG PASS MODE with a 0% peak.

The signaller waits in LISTENING mode.

PIG APPROACH is displayed as soon as the flux reading crosses the threshold. The time and date when the threshold was crossed is shown. The flux reading continues to show live flux readings.

PIG DETECTED is displayed and the DETECTION DELAY starts (see 4.5 DETECTION DELAY) as soon as the flux reading has stopped increasing for more than 0.5 seconds. The peak flux reading and time and date when the peak occurred is shown.

During the DETECTION DELAY the unit will keep logging readings until the internal event buffer is full or the CONTROL BUTTON is pressed. At this point the EVENT NN (event number) will appear on the screen. No other EVENTS will be detected or signalled during the DETECTION DELAY.

On completion of the DETECTION DELAY or if the DETECTION DELAY is bypassed by pressing the CONTROL BUTTON the signaller returns to LISTENING mode.

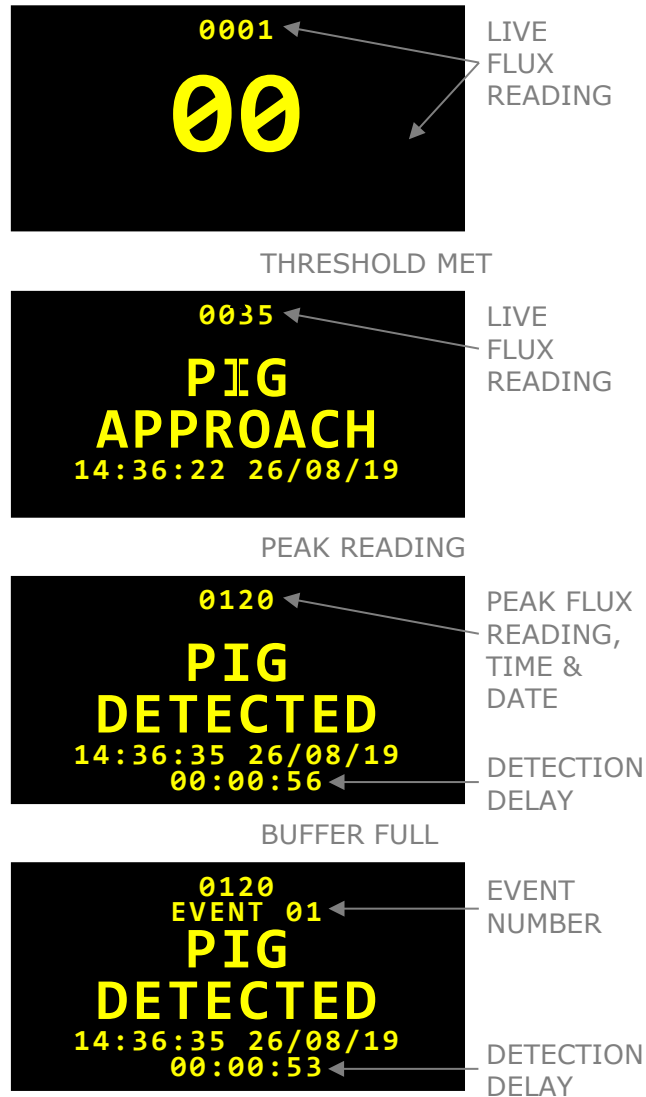



#### 4.4.2. PIG PASS MODE

PIG PASS mode is used to confirm pigs have passed the signaller. This is achieved by only signalling PIG PASSED if the flux readings drop by a user selectable percentage below the peak reading (5%, 10%, 25% or 50%). See 4.8.11 SET DETCT CRITERIA.

The signaller waits in LISTENING mode.

PIG APPROACH is displayed as soon as the flux reading crosses the threshold. The time and date when the threshold was crossed is shown. The flux reading continues to show live flux readings.

PIG PASSED is displayed and the DETECTION DELAY starts (see 4.5 DETECTION DELAY) as soon as the flux reading has dropped by the defined amount below the peak reading. The peak flux reading and time and date when the peak occurred is shown.

During the DETECTION DELAY the unit will keep logging readings until the internal event buffer is full or the CONTROL BUTTON is pressed. At this point the EVENT NN (event number) will appear on the screen. No other EVENTS will be detected or signalled during the DETECTION DELAY.

On completion of the DETECTION DELAY or if the DETECTION DELAY is bypassed by pressing the CONTROL BUTTON the signaller returns to LISTENING mode.

If PIG APPROACH is displayed but the pig stops near the signaller without causing a sufficient peak then the signaller shall return to LISTENING 3 minutes and 24 seconds after displaying PIG APPROACH without displaying PIG PASSED or starting the DETECTION DELAY. This will be logged as an event however no event will be signalled via the LEDs or any other interface such as relays or current loop.

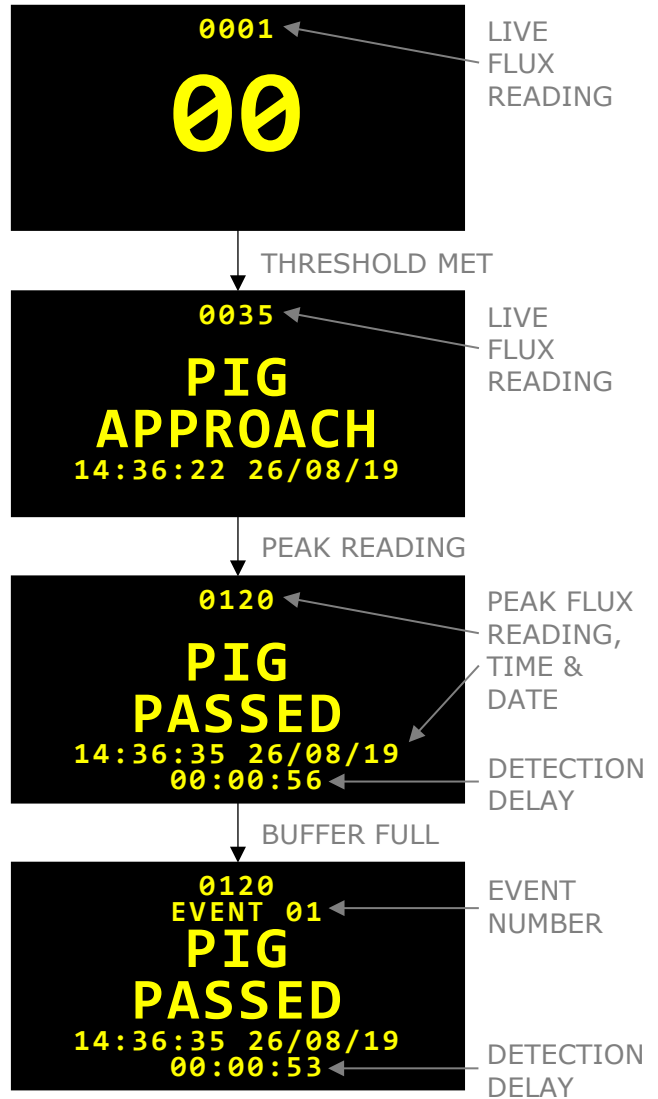

## 4.5. DETECTION DELAY

The DETECTION DELAY controls how long the unit will signal an event for. Usually, it will be configured to give the magnetic pig enough time to get out of range of the sensor after it has been detected to avoid re-trigger. When dealing with pig trains, the expected pig speed and separation should be used to configure a suitable value for the DETECTION delay such that the unit will not detect the same pig twice but will enter LISTENING mode in time to detect the next pig.

The DETECTION delay can be set to any value between 00:00:01 and 98:99:99 (in Hours:Minutes:Seconds format) using the CONTROL BUTTON or the 4000SD CONFIG software.

During the DETECTION DELAY the three LEDs above the display will flash every 1 second.

The DETECTION DELAY can be bypassed by pressing the CONTROL BUTTON.

### 4.5.1. DEBUG MODE

If the DETECTION DELAY is set to 00:00:00 then the 4000SD works in DEBUG mode, DEBUG MODE text is shown on-screen and NO detections will be signalled. DEBUG MODE is exited by setting the DETECTION DELAY to 00:00:01 – 99:99:99. If DEBUG MODE is set when in LOW POWER MODE, the signaller will exit LOW POWER MODE, which must be re-entered manually once DEBUG MODE is exited.

See also 4.7 SURVEY MODE.

### 4.5.2. LATCHED DETECTION DELAY

If the DETECTION DELAY HH (hours) field is set to 99 then when an EVENT occurs the 4000SD will latch indefinitely in DETECTION mode showing the EVENT information and flashing the 3x LEDs every 1 second. **Error! Reference source not found..** To begin LISTENING again the CONTROL BUTTON must be pressed.

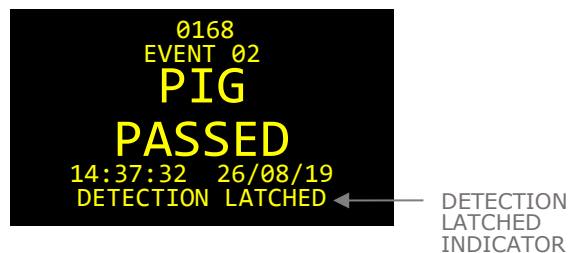

## 4.6. LOG MEMORY

The 4000SD is capable of logging up to 99 events with date, time, and the peak DIFFERENCE flux reading. Each log entry is capable of recording between 6.4 seconds and 3 minutes 24.8 seconds of data.

Once 99 events have been logged a MEMORY FULL warning will appear indicating that the logger memory is full, this warning will appear on PIG APPROACH, PIG PASSED and PIG DETECTED screens.

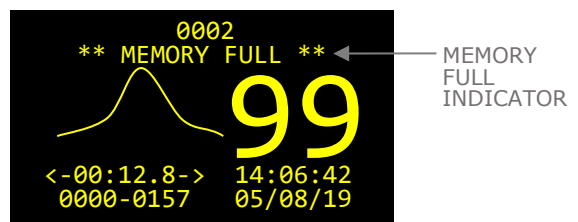

Subsequent events will be signalled but no data will be logged. Because of this behaviour it is important to erase all events prior to each deployment to ensure that the whole memory space is available.

## 4.7. SURVEY MODE

SURVEY MODE is an extended DEBUG MODE which gives a live, scrolling, graphical representation of the gauss readings received. The signaller remains in LISTENING mode and does not signal magnetic events. SURVEY MODE can be very useful for determining the magnetic signature of a pig however is not normally used for regular pig signalling.

SURVEY MODE is entered via the POWER menu on MENU level 2. The DETECTION DELAY is not altered in SURVEY MODE and is retained when SURVEY MODE is exited.

The vertical amplitude scale defaults to 80mG and increases automatically but must be manually rescaled to the default. The horizontal time scale default to an update every 0.1s and can be set using the SET SURVEY TIME item in MENU level 3, this setting is not remembered when the unit is switched off. Oldest data is always

The MENU can be entered with a single button press of <1 second. The graph can be reset (cleared) by pressing the CONTROL BUTTON for more than 1 second and less than 5 seconds. The data displayed can be logged by pressing the CONTROL BUTTON for 5 seconds, the DEBUG status changes to LOGGED and the CONTROL BUTTON can be released. Note that the displayed data logged is at the point where the PIG STATUS changes to LOGGED and not when the CONTROL BUTTON was pressed. The logged data can be viewed using the VIEW EVENT function in MENU level 1.

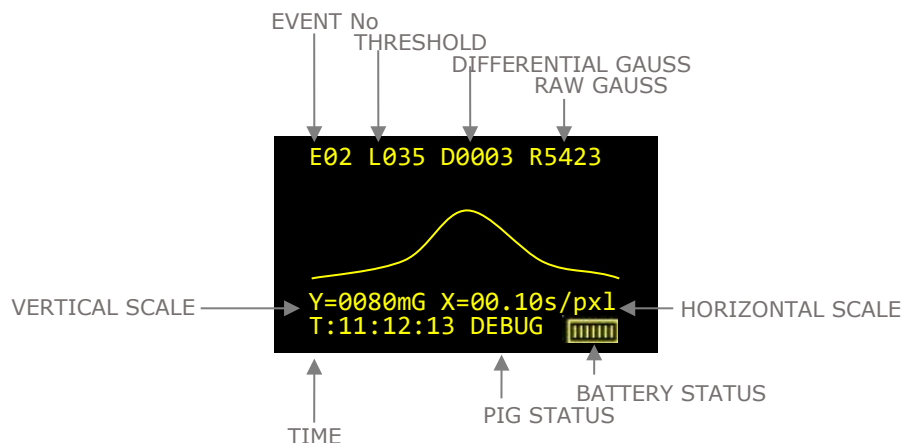

## 4.8. SINGLE BUTTON MENU INTERFACE

While the display is ON in LISTENING mode, the CONTROL BUTTON can be pressed to enter the menu interface. From the menus the user can configure several parameters which are discussed in this section.

While in the menu system, every time the user presses the CONTROL BUTTON the CURSOR will move down one line and the COUNTDOWN INDICATOR will be reset to 5. Once the CURSOR is pointing at the desired item the user simply allows the COUNTDOWN INDICATOR to reach 0 and the selected item will be executed. This simple behaviour is used throughout the menu interface to modify settings and interact with the 4000SD unit.

To modify parameters simply follow the instructions provided on screen. All parameters are incremented by pressing the CONTROL BUTTON until they are at the desired value then allowing the COUNTDOWN INDICATOR to reach 0.

If you do not wish to modify a parameter then simply allow the COUNTDOWN INDICATOR to reach 0 without operating the CONTROL BUTTON. The menu system is designed so that the 4000SD will always eventually start LISTENING again if the CONTROL BUTTON is left released for a long enough time.

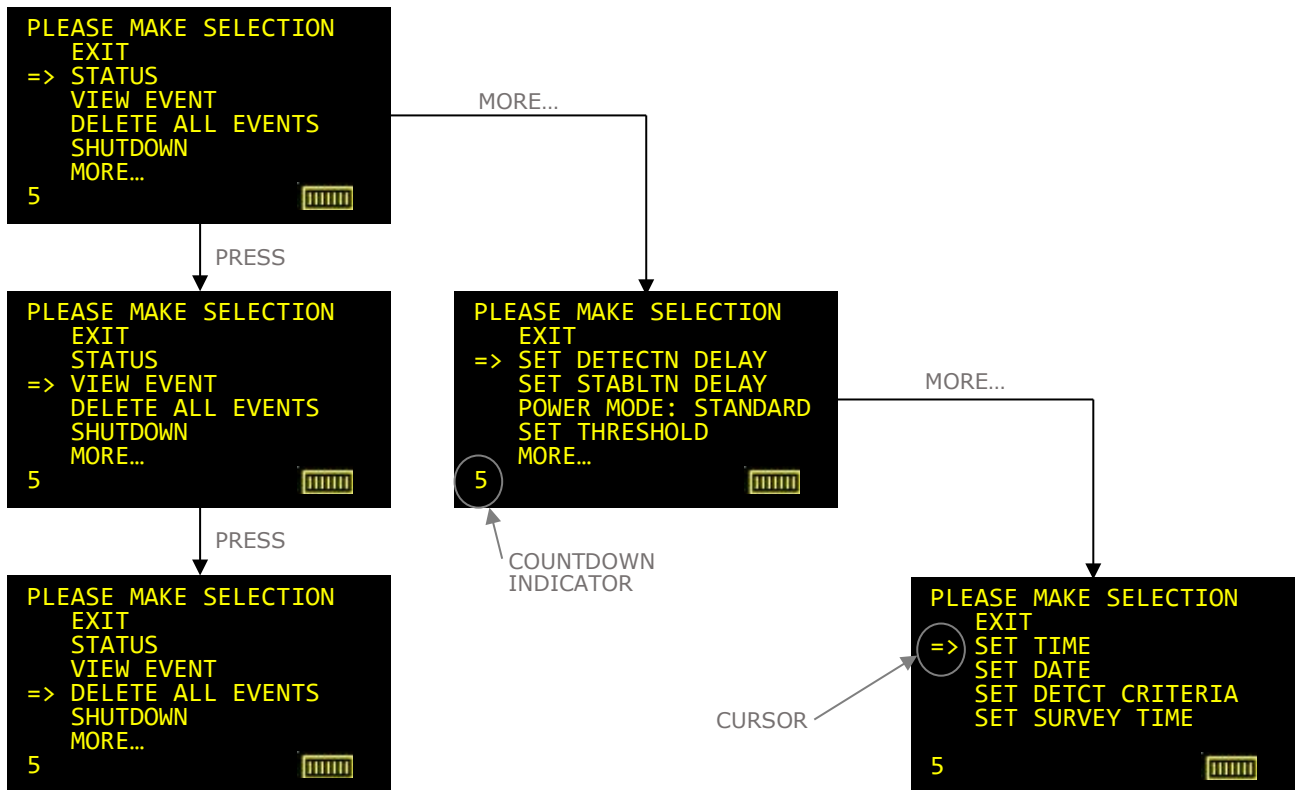

#### 4.8.1. EXIT

Every page of the menu system starts with EXIT. If EXIT is selected then the 4000SD will exit the menu system and resume LISTENING.

#### 4.8.2. STATUS

The STATUS screen is also shown at switch ON. It shows the Date, Time, Number of logged events, Stabilisation delay, Detection delay, Display delay, Threshold setting, and Firmware version. Ensure all of these settings are at the required values.

#### 4.8.3. VIEW EVENTS

Selecting this item will begin automatically cycling through all logged EVENTS from newest to oldest. Peak gauss reading, EVENT number, and EVENT date and time are shown. Each EVENT is shown for 5 seconds. If the CONTROL BUTTON is pressed at any point the 4000SD will exit and resume LISTENING.

#### 4.8.4. DELETE ALL EVENTS

Selecting this item will delete all logged EVENT data. A warning screen will be displayed saying "\*\*\* PRESS TO ERASE \*\*\*". To erase all events press the CONTROL BUTTON before the COUNTDOWN INDICATOR reaches 0. To cancel the erase simply allow the COUNTDOWN INDICATOR to reach 0 without pressing the CONTROL BUTTON.

#### 4.8.5. SHUTDOWN

Selecting this item switches off the 4000SD. The 4000SD is fitted with non-volatile memory which will remember most settings (such as the delays and THRESHOLD) until next time the unit is switched on. It is imperative that the 4000SD unit is turned off using this command rather than simply disconnecting the battery to allow any memory storage processes to terminate prior to turning OFF.

#### 4.8.6. MORE...

Selecting this item shows the next page of the menu system.

#### 4.8.7. SET DETECTION DELAY / STABILISATION DELAY

Refer to sections 4.5 DETECTION DELAY and 4.2 STABILISATION for more information regarding setting the DETECTION and STABILISATION delays.

#### 4.8.8. POWER MODE

Toggles between LOW POWER MODE, STANDARD MODE and SURVEY MODE. See section 4.3 LISTENING.

#### 4.8.9. SET THRESHOLD

**ADJUSTING THIS PARAMETER WITHOUT FIRST CONSULTING IK TRAX MAY CAUSE THE 4000SD TO MISS PIG PASSAGES OR GIVE FALSE DETECTIONS.** Selecting this item allows the THRESHOLD level to be configured which controls the sensitivity of the 4000SD. The standard THRESHOLD value is 035mG. Reducing the THRESHOLD value increases the sensitivity. The THRESHOLD can be configured to any value between 005mG and 999mG. See section 4.3 LISTENING for a brief explanation of the THRESHOLD value.

#### 4.8.10. SET DATE / TIME

Selecting these items allow the 4000SD date and time to be adjusted. Ensure that a valid time is entered in 24hour, HH:MM:SS format and a valid date in DD/MM/YY format.

#### 4.8.11. SET DETCT CRITERIA

This menu item allows selection of the DETECTION CRITERIA with the available options shown. The asterisk "\*" shows the current selection.

The % BELOW PEAK options allow for pig passage detection as per 4.4.2 PIG PASS MODE.

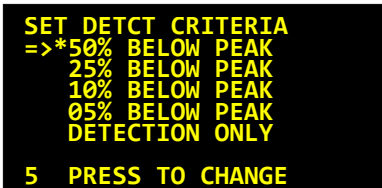

```
SET DETCT CRITERIA
=>*50% BELOW PEAK
 25% BELOW PEAK
 10% BELOW PEAK
 05% BELOW PEAK
DETECTION ONLY
5  PRESS TO CHANGE
```

The DETECTION ONLY option allows for general pig detection as per 4.4.1 PIG DETECT MODE.

#### 4.8.12. SET SURVEY TIME

This menu option is only available in SURVEY MODE. It allows the graph timescale to be set, default update rate is every 0.1s (0.1s/pixel) giving a visible graph time of 12.8 seconds. This value is not retained on power cycle.

Selectable options are:

Visible graph time	Update rate (s/pixel)
00:06.4	50mS
00:12.8	100mS
00:25.6	200mS
00:51.2	400mS
01:42.4	800mS
03:24.8	1.6S

#### 4.9. RAM MEMORY ERROR

The 4000SD contains a coin cell (BR2032) used to permanently power the Real Time Clock (RTC) circuitry which stores the date and time as well as other system variables such as LOW POWER mode while the unit is turned OFF.

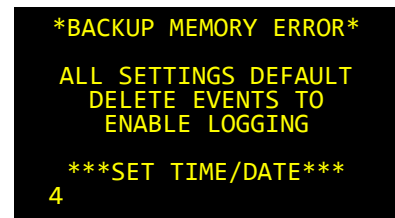

During the turn ON sequence the 4000SD conducts a self-check on the RTC circuitry. If any problems are found then the error message shown will be displayed and all system variables will reset to the default values shown below. The time and date menus will be entered in turn before continuing normal start up, if no adjustment are made, the time and date will start from 00:00:00 01/01/00

Please contact IK Trax if you see this message. The most likely cause is that the coin cell has expired. See section 7 MAINTENANCE AND STORAGE for more information.

```

LOW POWER MODE    ENABLED
MEMORY            FULL (99 EVENTS)
STABILISATION DELAY 00:01:00
DETECTION DELAY   00:01:00
THRESHOLD         035
    
```

#### 4.10. SWITCH ACTIVATED MESSAGE

If the 4000SD detects that either the CONTROL BUTTON or the ROV SWITCH (see section 4.13 ROV SWITCH OPTION) has been left activated or become faulty (e.g. a cable has been damaged and flooded) for more than 10 seconds then the message shown will be displayed to alert the user. The 4000SD will attempt to continue functioning however please contact IK Trax immediately if you see this message.

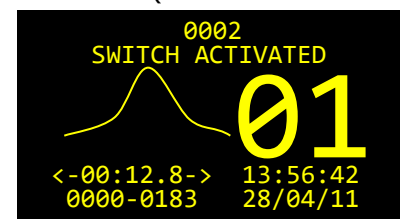

The message will clear if the switch deactivates and normal operation will resume.

## 4.11. BATTERY LIFETIME AND REPLACEMENT

As with all battery powered equipment the operating temperature which the 4000SD is used at alters the operating lifetime. Typically colder temperatures shorten the lifetime. For the standard Alkaline pack the lifetime at +20°C will typically be 20% more than the lifetime at +0°C. Please contact IK Trax for more details or to discuss your requirements.

LOW POWER MODE provides an advantage while the 4000SD is LISTENING only because the display is OFF for most of the time. If the 4000SD is SIGNALLING in LOW POWER MODE the battery lifetime will be the same as the STANDARD POWER MODE because the display is always ON.

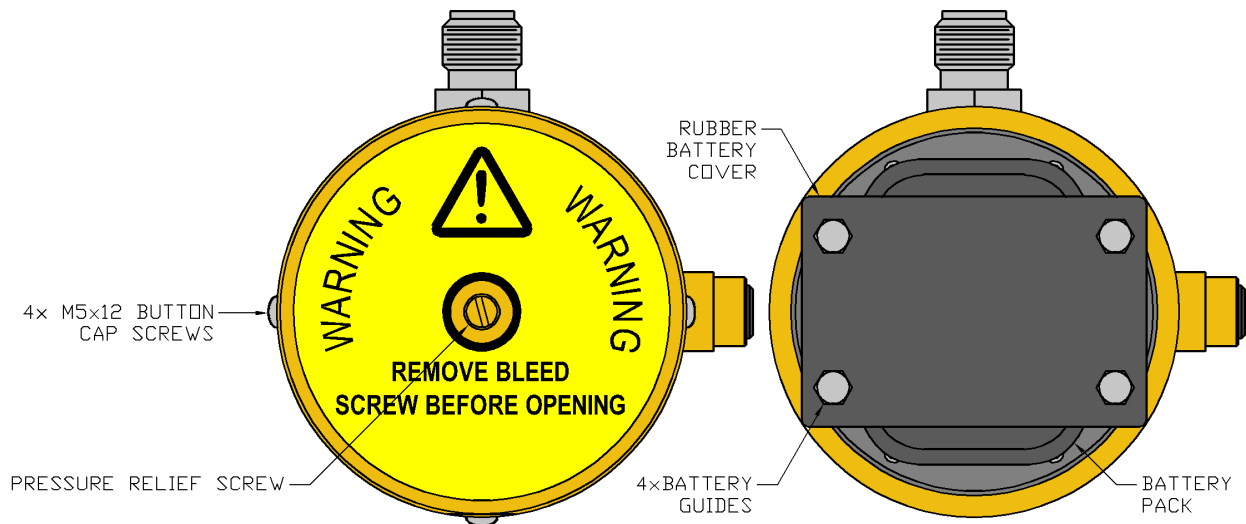

1. Opening of the unit should only take place in a clean, dry, laboratory environment.
2. To prevent the formation of condensation within the unit allow the unit to stabilise within the laboratory environment for a minimum of 6 hours prior to opening.
3. Loosen the bleedscrew to relieve any internal pressure prior to opening.
4. Remove the 4x M5 screws around the perimeter of the housing.
5. Carefully remove the housing from the endcap. Ensure that the Oring seals are protected from damage and contamination while the unit is open.
6. Carefully pull off the rubber battery cover.
7. Ensure the unit is turned OFF before disconnecting the battery. Replace the battery. Ensure all wires are installed neatly and protected from accidental damage.
8. Examine the Oring seals for any signs of damage or contamination. Replace if necessary. Ensure the spiral tails of the Back-Up Rings do not protrude from the assembly before fitting the Endcap. These can be secured in place with silicone grease.
9. Reassemble the unit following the above instructions in reverse.
10. Tighten the bleedscrew.

## 4.12. EXTERNAL CONNECTIONS

IF THE EXTERNAL CONNECTOR IS UNUSED IT MUST BE FITTED WITH A SUITABLE BLANKING CONNECTOR (e.g. Burton 5501-1508-0000) TO PREVENT CONDUCTION BETWEEN THE PINS AND MALFUNCTION.

The Burton 5507-1508, 8 way, bulkhead connector to provide connection to external power and communications the standard connections will be as shown below (BURTON 5507-1508 BCR MATING FACE).

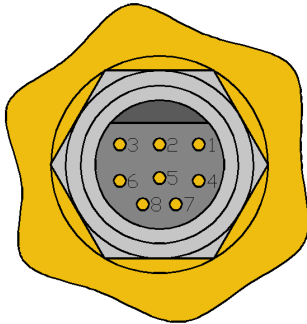

BURTON CONNECTION	SIGNAL
1	GND
2	TxD
3	RxD
4	NO CONNECTION
5	SW
6	NO CONNECTION
7	RELAY NO1
8	RELAY CM1

## 4.13. ROV SWITCH OPTION

For some applications an ROV SWITCH is provided which is connected via the Burton connector on top of the 4000SD as shown in section 5 DEPLOYMENT. The ROV SWITCH behaves in an identical way to the manual control button fitted to the 4000SD. Either the manual control button, or the ROV SWITCH can be used to control the unit.

The ROV SWITCH is a robust, rotary switch which can be rotated indefinitely in either direction. The ROV SWITCH contact will be closed (equivalent to 4000SD manual control button pressed) when in the 12 o'clock, 'ON' position and will be open (equivalent to 4000SD manual control button released) at positions at or below the horizontal, red, 'OFF' lines. When not in use the ROV switch should be rotated 180° away from the ON position to prevent accidental activation, it may also be fixed in this position with a plastic tie wrap using the 'locking' hole provided.

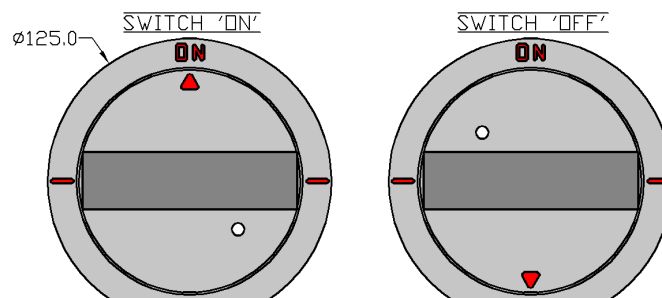

## 4.14. INTERFACE OPTIONS

The 4000SD can be interfaced with external equipment such as an acoustic data modem, a dual rate pinger, a strobe unit, or other equipment. IK Trax will typically supply a custom 'Y' spliced cable with unique subsea connectors at each end.



## 5. DEPLOYMENT

The following section does not provide a comprehensive deployment procedure as every deployment is different however it does outline the minimum checks which should be carried out before each and every deployment. Repeating these checks before each and every deployment will pick up most problems before the unit is deployed and can save significant costs and avoid unnecessary delays. If the results of any of these checks are not as expected then please contact IK Trax immediately.

1. At least 24 hours prior to deployment any personnel who will be involved with the operation of the 4000SD should review this entire manual to familiarise themselves with the unit. They should also be allowed time to operate the unit and cause magnetic events using a magnetic object or by moving the unit itself. Simply allowing personnel to 'play' with the unit before it is actually deployed can save significant costs compared to deploying the unit without understanding how it works and then suffering from an unnecessary operator error.
2. Ensure that any unused connectors are properly blanked (e.g. with Burton #5501-1508-0000) to prevent conduction between pins and malfunction when submerged in saltwater.
3. Visually inspect all cables and connectors for any signs of damage. Ensure that all connectors are lightly lubricated with a suitable silicone grease. Confirm that all connectors are securely mated.
4. Ensure the bleed screw has been tightened.
5. Referring to section 5.1 MOUNTING confirm that the 4000SD is suitably and securely mounted.
6. Turn the unit ON as described in section 4.1 TURNING ON. Confirm that no RAM MEMORY ERROR is seen as per section 4.9 RAM MEMORY ERROR.
7. Confirm that the BATTERY INDICATOR is showing full. IK Trax recommend fitting a new battery prior to each deployment to maximise available lifetime while deployed.
8. Referring to section 4.8.2 STATUS confirm that the time and date are correct.
9. Referring to sections 4.8.2 STATUS and 4.3 LISTENING confirm that the required POWER MODE is selected.
10. Referring to section 4.2 STABILISATION confirm that a suitable STABILISATION delay has been configured.
11. Referring to section 4.5 DETECTION DELAY confirm that a suitable DETECTION delay has been configured.
12. Referring to sections 4.3 LISTENING and 4.8.9 SET THRESHOLD confirm that a suitable THRESHOLD has been configured.
13. Referring to section 4.8.11 SET DETCT CRITERIA confirm that a suitable DETECTION CRITERIA has been configured
14. Confirm that the unit is not in DEBUG MODE as per section 4.5.1 DEBUG MODE or SURVEY MODE as per section 4.7 SURVEY MODE.
15. Confirm the unit is not displaying a SWITCH ACTIVATED message as per section 4.10 SWITCH ACTIVATED MESSAGE.

16. As per section 4.3 LISTENING confirm that while LISTENING the LIVE GAUSS reading is flickering between values of 0000 and less than 0005 assuming that the 4000SD is in a magnetically quiet environment.
17. Gradually bring a magnetic object (most hand tools, such as screw drivers, have sufficient magnetism) near to the sensor, the sensor is positioned as shown in section 1 GENERAL DESCRIPTION. The LIVE GAUSS reading should gradually increase. Confirm that a DETECTION occurs when the LIVE GAUSS reading exceeds the THRESHOLD. Confirm that the EVENT number increments, the EVENT date and time are correct, and the LEDs flash every 1 second during the DETECTION delay. See sections 4.3 LISTENING and 4.4 DETECTION MODES as necessary.
18. After the DETECTION delay ensure the 4000SD begins LISTENING again. Cause several more events taking a note of their time and date and then referring to section 4.8.3 VIEW EVENTS confirm they were all logged successfully.
19. Operate the 4000SD CONTROL BUTTON and ensure that it is functioning as expected.
20. If applicable, referring to section 4.13 ROV SWITCH OPTION, operate the ROV switch and confirm that it is functioning as expected. Ensure that it is left in the 'OFF' position.
21. If applicable, referring to section 4.14 INTERFACE OPTIONS, confirm that any external equipment is functioning as expected.
22. Prior to each deployment the EVENT memory should be erased as per section 4.8.4 DELETE ALL EVENTS. The memory can hold up to 99 EVENTS, once 99 EVENTS have been stored the 4000SD will signal subsequent magnetic events but will not log any data. After the memory has been erased confirm that the LISTENING screen shows the EVENT number 00 and no date or time.

## 5.1. MOUNTING

The 4000SD must be mounted securely. Any movement and/or excessive vibration must be avoided. If the unit is allowed to move within the earths' magnetic field then it will detect this change and cause a DETECTION. There are two main options for mounting:

**STRAP MOUNTED.** The 4000SD is provided with a MOUNTING PLATE which allows ratchet straps or banding to be used to clamp the unit onto a pipeline.

**ROV DEPLOYMENT CRADLE.** The 4000SD is provided on a custom CRADLE designed to the customers' specification. This cradle 'clips' securely onto the pipeline and may include additional equipment such as a rotary ROV operated switch, flashing strobe, acoustic transmitter etc.

The 4000SD is shown here mounted in the optimum position for magnetic pig detection with the magnetic sensor oriented properly and as close as possible to the pipeline wall. Do not modify the position of the 4000SD on the BASE or CRADLE without consulting IK Trax.

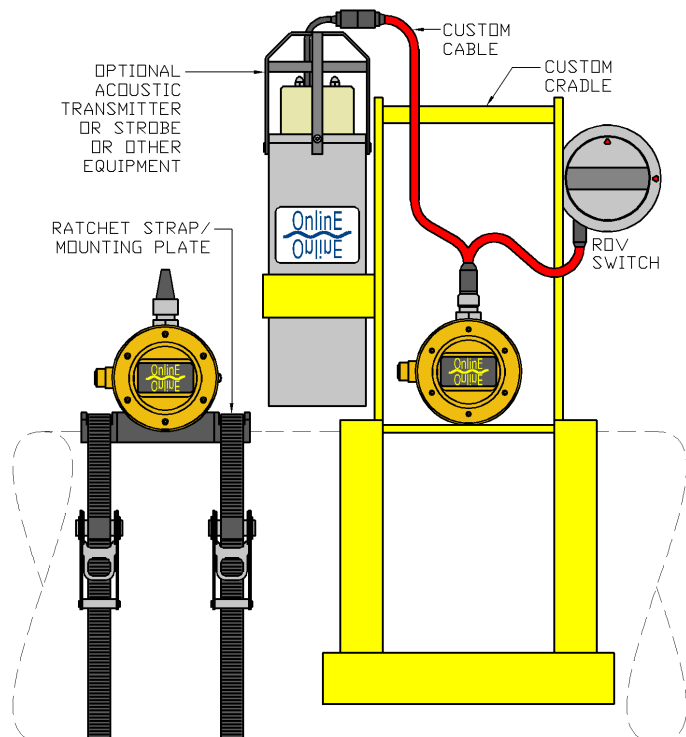

## 5.2. RECOMMENDED MAGNET ARRANGEMENT

It is recommended that pigs be fitted with 4x or more rare earth magnets (neodymium iron boron) spaced equally around the pig body with the same poles facing outwards e.g. all north poles facing outwards (as shown) or all south poles facing outwards. It is critical that the magnets are not oriented with a mixture of north and south poles facing outwards as this may result in 'dead-spots' in the magnetic field around the pig. Magnets may be embedded in foam pigs in a similar fashion. The cost of quality magnets is insignificant compared to the potential cost of a lost pig if unsuitable, cheaper magnets are used. Contact IK Trax for a quote for suitable magnets. Effective pig detection is dependent on several factors including:

**PIPE WALL THICKNESS** – The thinner the pipe wall, the stronger the magnetic signal.

**PIPELINE MATERIAL** – Different materials cause different attenuations to the magnetic signals. For example, 50mm of concrete will affect the signal considerably less than 50mm of mild steel.

**DISTANCE BETWEEN MAGNET AND SENSOR** – The closer the magnets are to the magnetic sensor, the stronger the magnetic signal.

**NUMBER OF MAGNETS FITTED TO PIG** – The more magnets which are placed around the pig, the more uniform and effective the overall magnetic field is.

**STRENGTH OF MAGNETS** – The stronger the magnets, the stronger the magnetic signal.

**BACKGROUND MAGNETIC NOISE** – The more magnetically quiet the surrounding area is, the more sensitive the 4000SD can be set without the risk of false triggers. Large magnetic objects (such as vehicles or tools) moving nearby can cause large magnetic signals, the magnetic signal from the pig must be significantly larger than these to allow reliable detection.

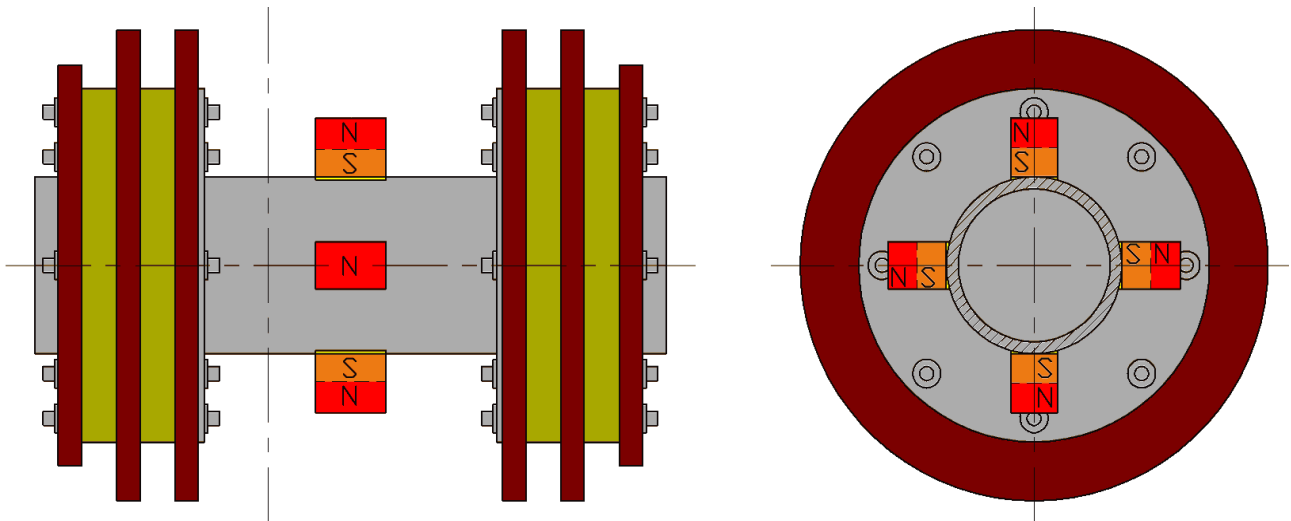

## 6. SOFTWARE

The 4000SD transmits and receives serial data in ASCII format at 9600 baud, 8 Data bits, No parity, 1 Stop bit, and with No Flow control. Any terminal program such as HyperTerminal or TeraTerm configured with these settings can be used to communicate with the unit while the unit is in LISTENING mode.

IK Trax supply dedicated software which is described in this section. In the following descriptions of the 4000SD SOFTWARE examples of the equivalent ASCII command formats are shown in *italics*. The image below shows a screenshot of the 4000SD SOFTWARE.

The screenshot displays the software interface for the 4000SD. The top header features the Online Electronics Ltd logo. The interface is divided into several sections:

- Connection:** Shows 'Available COM Ports' with 'COM37' selected. 'Connect' and 'Disconnect' buttons are present. A status bar indicates 'COM37 connected.'
- Controls:** Includes buttons for 'Show (S) tatus', 'Set Date and (T) ime', 'Set Sta (B) ilisation Delay', 'Set (D) etection Delay', 'Set (P) ower Mode', 'Set Thresho (L) d', '(U) nload Log', '(E) rase Log', 'System status', 'Sync to PC time 02/09/20, 12:03:27', and 'Start Capture'/'Stop Capture' buttons.
- Data:** A scrollable text area shows the following output:

```
*****  
4000SD Online Electronics 2019 A05  
*****  
(T) Time: 02/09/20,11:57:07  
(U) Logged events (E): 00/99  
(B) Stabilisation delay: 00:01:00  
(D) Detection delay: 00:01:00  
(P) Power Mode STANDARD  
(L) Threshold Level: 035mG  
*****  
05250 05247 00003
```
- Graphics:** A plot area with a y-axis from 0 to 10. The plot shows a red signal that is mostly flat at a level of 2, with several sharp downward spikes reaching 0. The 'Difference' checkbox is checked, and a 'Graphics' button with a play icon is visible.

### Connection

This section contains controls for connecting to the 4000SD.

**Available COM Ports** – This drop-down menu will show all available COM ports on the computer. When the 4000SD USB download cable is connected to the PC it will appear in this menu.

**Connect** – This button attempts to connect to the COM port selected in the Available COM Ports drop down menu.

**Disconnect** – This button disconnects from the COM port currently connected.

## Controls

This section contains controls for configuring all parameters within the 4000SD. All of these parameters can also be configured using the CONTROL BUTTON.

**Show (S)tatus** – This button shows the system status in the Data window. *S*

**Set Date and (T)ime** – This button synchronises the 4000SD internal time and date with the PC time and date. *T13:05:56,28/04/11*

**Set Sta(B)ilisation Delay** – This button sets the STABILISATION delay. *B00:01:00*

**Set (D)etection Delay** – This button sets the DETECTION delay. *D00:01:00*

**Set (P)ower Mode** – This button sets to LOW or STANDARD power mode. *P1 or P0*

**Set Thresho(L)d** – This button sets the THRESHOLD level. *L035*

**(U)nload Log** – This button causes the 4000SD to unload all logged data. *U*

**(E)rase Log** – This button erases all logged data from the 4000SD memory. *E*

**Start Capture** – Pressing this button will prepare a log file to save data into.

**Stop Capture** – Pressing this button will save data into the previously defined log file. If the software is closed before this button is pressed then any received data will be lost. After pressing this button always open up the log file to check that the required data has been saved before closing the software.

## Data

This section contains a window which shows all data received from the 4000SD. The 4000SD should transmit a continuous stream of data when in LISTENING mode. The 3x numbers at the bottom of the window show RAW flux readings, FILTERED flux readings, and the unsigned DIFFERENCE between RAW and FILTERED readings respectively. If the DIFFERENCE reading ever exceeds the THRESHOLD then a DETECTION will occur once the DIFFERENCE has peaked.

**Graphics play icon** – Pressing this button will start plotting a graph of the live 4000SD sensor readings while in LISTENING mode. The graph width is 10 seconds and either Raw Flux or Difference can be plotted by selecting the **Raw Flux** or **Difference** check box. This graph can be useful for visualising background noise levels and/or pig magnetic signatures. If the DETECTION delay is configured as 00:00:00 then the 4000SD will enter DEBUG mode during which it will only LISTEN, not log or signal events.

## **6.1. SOFTWARE CONNECTION AND DATA UNLOAD**

1. Connect the USB end of the 4000SD USB download cable to the PC.
2. Connect the Burton end of the 4000SD USB download cable to the 4000SD unit.
3. Turn the 4000SD unit ON by pressing and holding the control button until the IK logo appears on the display. Wait until the 4000SD unit is LISTENING.
4. Open the software and select the correct COM port which the 4000SD USB download cable is connected to in the "Available COM Ports:" drop down menu. If the correct COM port number is not known then each available COM port can be tried in turn until the correct one is found or the correct COM port can be identified from the Device Manager within windows (right click on My Computer> Properties> Device Manager).
5. Press the "Connect" button to connect to the 4000SD unit. Data should be being received constantly in the data window if the unit is in LISTENING mode. A graph of this data can be plotted by pressing the "Graphics play" button within the Controls section.
6. Press the "Start Capture" button to start capturing data coming from the 4000SD unit. A "Save As" window will appear prompting the user to define a text file to store the data within. Ensure that this file is located somewhere easy to find such as on the Desktop.
7. Press the (U)nload Log button to command the 4000SD to transmit all logged data to the PC. A stream of data will appear in the "Data" window.
8. Once the 4000SD has sent all logged data it will resume LISTENING as normal. At this point press the "Stop Capture" button within the software to save the logged data to the file specified previously. If the software is closed before pressing "Stop Capture" then the data received by the software will not be saved and the unload procedure will need to be repeated.
9. Open the log file and ensure that the required data has been stored. This data can be pasted directly into a spreadsheet or other document if required for analysis.
10. At this point the data on the 4000SD unit can be erased by selecting the ERASE ALL EVENTS option within the display menu or by pressing the (E)rased Log button.
11. Press the "Disconnect" button to disconnect from the 4000SD unit. Exit the software and turn the 4000SD unit OFF by selecting SHUTDOWN within the display menu.

## **6.2. SOFTWARE INSTALLATION**

There are three stages to the software installation. Instructions for each stage are given below.

### **6.2.1. MICROSOFT .NET FRAMEWORK INSTALLATION**

The software supplied by IK Trax requires the Microsoft .NET Framework to be installed on the host PC. For more information about the .NET, or to download the latest version, visit [www.microsoft.com/net](http://www.microsoft.com/net). A version can also be found on the software CD/USB supplied by IK Trax and can be installed by following the instructions below.

1. Log into the host PC as an administrator with full administrator rights.
2. Execute the dotNetFx40\_Full\_x86\_x64.exe file found in the .NET folder on the CD/USB.
3. Follow all instructions provided on screen to complete the installation.

### **6.2.2. 4000SD SOFTWARE INSTALLATION**

The 4000SD unit transmits data in ASCII format at 9600 baud, 8 Data bits, No parity, 1 Stop bit, and with No Flow control. Any terminal program such as HyperTerminal or TeraTerm configured with these settings can be used to receive the logged data.

The 4000SD software supplied by IK Trax is basically a simple terminal program which receives ASCII data from a COM or serial port. It also includes some more advanced features such as the ability to log incoming data and generate graphs of readings coming from the 4000SD. To install the dedicated software supplied by IK Trax follow the instructions below.

1. Log into the host PC as an administrator with full administrator rights.
2. Execute the setup.exe file found in the 4000SD SOFTWARE folder on the CD/USB.
3. Follow all instructions provided on screen to complete the installation.
4. The software will now be available in the Start menu.

### **6.2.3. USB-RS232 DRIVER INSTALLATION**

The 4000SD download cable includes a USB to RS232 converter which requires VCP (Virtual COM Port) drivers to be installed on the host PC. For more information, or to download the latest version, visit [www.ftdichip.com/FTDrivers.htm](http://www.ftdichip.com/FTDrivers.htm). A driver can be found on the software CD/USB supplied by IK Trax and can be installed by following the instructions below.

1. Log onto the host PC as an administrator with full administrator rights.
2. Connect the USB to an available USB port on the host PC. If windows does not already have suitable drivers installed it will automatically detect the device and prepare to install drivers.
3. When prompted to, point windows towards the RS232 DRIVERS folder on the CD/USB.
4. Follow all instructions provided on screen to complete the installation.

## 7. MAINTENANCE AND STORAGE

All IK Trax products are designed to require minimum maintenance. The housing should be cleaned using fresh water and cleaning agents as necessary. Do not use chemicals which could be damaging to the housing, the nitrile rubber O-rings, the acrylic window, or any connectors.

Periodically inspect all connectors and cables for any signs of damage. Connectors should be cleaned and lightly lubricated with a suitable silicone grease to ensure that dirt, water ingress, and corrosion problems do not arise.

The 4000SD contains a coin cell (BR2032) used to permanently power the Real Time Clock circuitry which stores the date and time as well as other system variables such as LOW POWER mode while the unit is turned OFF. This battery should be replaced every 5 years at IK Trax premises.

If the unit is to be placed in storage for a long period of time ensure the unit has been cleaned and disconnect the batteries.

### 7.1. O-RING REPLACEMENT

The product uses the following O-rings:

- 1x 50-008 groove in piston bleedscrew O-ring.
- 1x 50-236 groove in flange window O-ring.
- 1x 50-237 groove in piston window O-ring.
- 2x 50-243 groove in piston endcap O-rings with 2x 250-243 PTFE Back Up Rings.

Ensure the free space at the tails of the spiral back up rings are filled with silicone grease and then apply a layer of grease over the seams to secure them in place. The spiral tails should not protrude from the assembly.

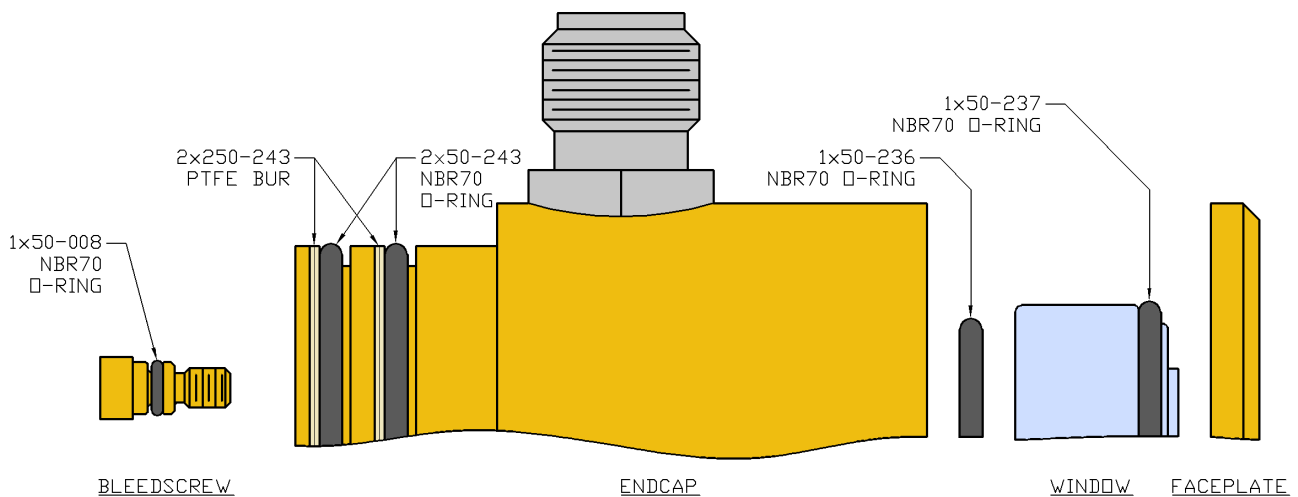



## **7.2. CABLES / CONNECTORS**

Subsea rated connectors require regular cleaning and lubrication to ensure that contacts are clean, electrically isolated from each other and to prevent water intrusion when wet or submerged. Before every deployment all subsea rated connectors and cables should be visually inspected for any visible signs of cable sheath damage, crush damage, bending damage, poorly mated or misaligned connectors etc. Seal all unused connectors with appropriate blanking caps or plugs to prevent water ingress and corrosion. Every time a connector is unmated and at least every 6 months all connectors should be inspected. The following maintenance and operation instructions should be followed very carefully to ensure a reliable performance of the connectors.

### **7.2.1. CONNECTOR ENGAGEMENT (MATING)**

1. Lightly coat the face, sides and sealing surface of the plug with clean Molykote 111 compound (or Silicone grease) sparingly. Be sure there is no moisture on the components.
2. Align the polarising keyway in plug and receptacle and push squarely together, with no twisting motions, to engage the contacts. Push the plug in until the rubber sealing surface and the metal sealing surface touch. A gentle rocking motion will allow trapped air to escape. Using the coupling nut as an aid to engagement is acceptable but never use a wrench.
3. When the sealing surfaces touch, engage the coupling nut until it just touches and give it an additional one full turn (for 15 size). Note that the sealing surfaces must be touching for the additional half turn to seal the connector properly. If the coupling nut is used as an aid to engagement, back the nut off completely to obtain visual confirmation of the sealing surface contact. Then spin the nut back on and add the turn. Applying more turns than specified will distort the rubber, possibly resulting in leakage and/or physical damage. Locking sleeves should be tightened firmly by hand only, when the connector is subsea the water pressure will hold the connections tightly together.

### **7.2.2. CONNECTOR DISENGAGEMENT (UNMATING)**

1. Unscrew the coupling nut completely. Note that after deep initial dives the nut may be loose. This is normal.
2. Grasp the connector body firmly and pull the plug out with no rocking or twisting motions. Do not disengage the plug by pulling on the cable, it may break a wire inside the connector.

### **7.2.3. CONNECTOR CLEANING AND RE-USE**

1. Clean the plug and receptacle carefully by hand. Use only a bristle brush (no metal allowed), liquid soap and water. Then clean with a suitable contact cleaner and lubricant. Do not use chemicals which could damage the connector rubber such as WD40
2. Dry the connection by shaking off excess water then use alcohol to eliminate the remaining water as described below.
3. Flood the connector with alcohol, then pour it out and allow the connector to air dry. Compressed air contains many contaminants such as water, oil and dust and should not be used.

#### **7.2.4. CONNECTOR INSPECTION**

1. Inspect the connector for bent or otherwise damaged pins and corrosion.
2. Metal sealing surfaces must have an RMS 32 finish and be free of scratches, nicks and dents. This applies to both O-ring sealing surfaces and connector sealing surfaces.
3. The rubber sealing surfaces must be free of cuts, nicks and tears. On used connectors, the rubber sealing surface may have an impression of the metal sealing surface on it. This is normal.
4. The cable and rubber-moulded plug must be free of cuts, tears and separations. Carefully inspect the rubber condition near the metal shell. Tears are common here, caused by using the connector in a bent position or using it as a handle.
5. When the connectors are being re-used, remember to always use new O-rings in the receptacles, if marked or damaged, and to inspect the threads of the coupling nut for the presence of dry-film lubrication used to prevent galling of the metal. A light coat of moly lube may be used if necessary.
6. Apply a thin coat of silicone grease. It is of the utmost importance to use silicone grease sparingly. Light films reduce friction and allow the components to work as they are designed. Larger quantities create the equivalent of a "hydraulic lock" and completely destroy the function of the O-ring and connector.

## 8. DISPOSAL OF UNIT

IK Trax takes its responsibilities under the WEEE Regulations extremely seriously and has taken steps to be compliant in line with our corporate and social responsibilities. In the UK, IK Trax has joined a registered compliance scheme WeeeCare (registration number **WEE/MP3538PZ/SCH**).

Electrical and electronic equipment should never be disposed of with general waste but must be separately collected for the proper treatment and recovery.

The crossed out bin symbol, placed on the product, reminds you of the need to dispose of it correctly at the end of its life.

When buying a new product you will have the possibility to return, free of charge, another end of life product of equivalent type that has fulfilled the same functions as the supplied equipment. These items may be deposited at:

Online Electronics Ltd  
Doing business as IK Trax  
Woodburn Road  
Blackburn Business Park  
Blackburn  
Aberdeen  
AB21 0PS  
UK

Alternatively, to arrange a collection of any waste electrical equipment, obligated to IK Trax please telephone WeeeCare on **0844 800 2004**.

## 9. WARRANTY

IK Trax products are guaranteed for one year from the date of purchase. Goods should be returned transportation prepaid to IK Trax.

There is no charge for parts or labour should any product require repair due to a manufacturing deficiency during the guarantee period.

In the event of a manufacturing deficiency the inward transportation costs will be repaid to the client.