



TRAX

**Intelligent Pipeline
Technology**

6001SD Operating Manual

Subsea Data Logger



| CONFIGURATION INFORMATION | |
|----------------------------------|--|
| 6001 SERIAL NUMBER | |
| SENSOR 1 SERIAL NUMBER | |
| SENSOR 1 FULL SCALE RANGE | |
| SENSOR 1 FULL SCALE ACCURACY | |
| SENSOR 2 SERIAL NUMBER | |
| SENSOR 2 FULL SCALE RANGE | |
| SENSOR 2 FULL SCALE ACCURACY | |

CONTENTS

Page

| | | |
|---------|--|----|
| 1. | GENERAL DESCRIPTION | 4 |
| 2. | SPECIFICATIONS | 5 |
| 3. | RULES FOR SAFE OPERATION | 6 |
| 4. | OPERATION | 7 |
| 4.1. | TURNING ON | 7 |
| 4.2. | SINGLE BUTTON MENU INTERFACE | 8 |
| 4.2.1. | EXIT | 9 |
| 4.2.2. | STATUS | 9 |
| 4.2.3. | UNLOAD | 9 |
| 4.2.4. | SET LOG & TEST DETAILS | 9 |
| 4.2.5. | SET LOG INTERVAL | 10 |
| 4.2.6. | ENABLE/DISABLE LIMITS OR PRESSURE TEST | 10 |
| 4.2.7. | SHUTDOWN | 10 |
| 4.2.8. | MORE | 10 |
| 4.2.9. | LOW POWER ENABLED / DISABLED | 10 |
| 4.2.10. | DP ENABLED/DISABLED | 10 |
| 4.2.11. | MEM OVER ENABLED / DISABLED | 11 |
| 4.2.12. | CONFIGURE ALARM | 11 |
| 4.2.13. | SENSOR ENABLED / DISABLED | 11 |
| 4.2.14. | SENSOR ADDRESSES | 12 |
| 4.2.15. | SET UNITS | 13 |
| 4.2.16. | SET TIME & DATE | 13 |
| 4.2.17. | SET TIME | 13 |
| 4.2.18. | SET DATE | 13 |
| 4.2.19. | SET CONTRAST | 13 |
| 4.2.20. | CONFIGURE OUTPUT | 13 |
| 4.2.21. | ERASE LOG | 14 |
| 4.3. | LIMITS DISPLAY | 15 |
| 4.4. | PRESSURE TEST FUNCTION | 15 |
| 4.5. | RAM ERROR | 17 |
| 4.6. | MEMORY FULL | 17 |
| 5. | DATA UNLOAD | 18 |
| 5.1. | LOGGING CAPACITY | 18 |
| 5.2. | 6000 XMODEM UNLOAD SOFTWARE | 18 |
| 5.3. | UNLOAD DATA OUTPUT | 20 |
| 5.3.1. | LOGGED DATA FORMAT | 20 |
| 6. | BATTERY REMOVAL | 21 |
| 6.1. | BATTERY LIFETIME | 21 |
| 7. | SOFTWARE INSTALLATION | 22 |
| 7.1. | MICROSOFT .NET FRAMEWORK INSTALLATION | 22 |
| 7.2. | 6001SD SOFTWARE INSTALLATION | 22 |
| 7.2.1. | USB-RS485 DRIVER INSTALLATION | 22 |
| 8. | EXTERNAL CONNECTIONS | 23 |
| 9. | CALIBRATION | 24 |
| 9.1. | PRESSURE SENSOR CALIBRATION | 24 |
| 9.2. | TEMPERATURE CALIBRATION | 24 |
| 9.3. | SENSOR REPLACEMENT | 24 |
| 9.4. | PRESSURE SENSOR SEALING WASHERS | 25 |
| 10. | OPTIONAL ACCESSORIES | 26 |
| 10.1. | ROV SWITCH OPTION | 26 |
| 10.2. | ACOUSTIC MODEM OPTION | 26 |
| 10.3. | OPTICAL MODEM OPTION | 26 |
| 11. | DEPLOYMENT CONSIDERATIONS | 28 |
| 11.1. | MOUNTING | 28 |
| 12. | MAINTENANCE | 29 |
| 12.1. | O-RING REPLACEMENT | 29 |
| 12.2. | SUBSEA CABLES / CONNECTORS | 30 |

12.3. ROUTINE MAINTENANCE AND STORAGE 30
 13. DISPOSAL OF UNIT 31
 14. WARRANTY 31

| Revision | Updated By | Description of Update | Update Date |
|-----------------|-------------------|------------------------------|--------------------|
| A | BG | CR-24-01-04-01: New format | 03/03/24 |
| | | | |
| | | | |
| | | | |
| | | | |

1. GENERAL DESCRIPTION

The 6001SD Temperature and Pressure Subsea Logger is a compact, self-contained, subsea unit which logs and displays readings from internal digital pressure sensor(s), in BAR or PSI, and temperature sensor(s), in Celsius or Fahrenheit. A high visibility OLED display shows the current readings subsea. The user can turn the unit on and off as well as modify all available settings using a single control button and intuitive menu system.

The 6000 is particularly useful for hydrostatic testing of pipelines where features such as the LIMITs display, DNV Hydrotest function* and the RS485 interface mean that a successful test can be confirmed without needing to recover the unit for download of data.

*features dependent on firmware version installed

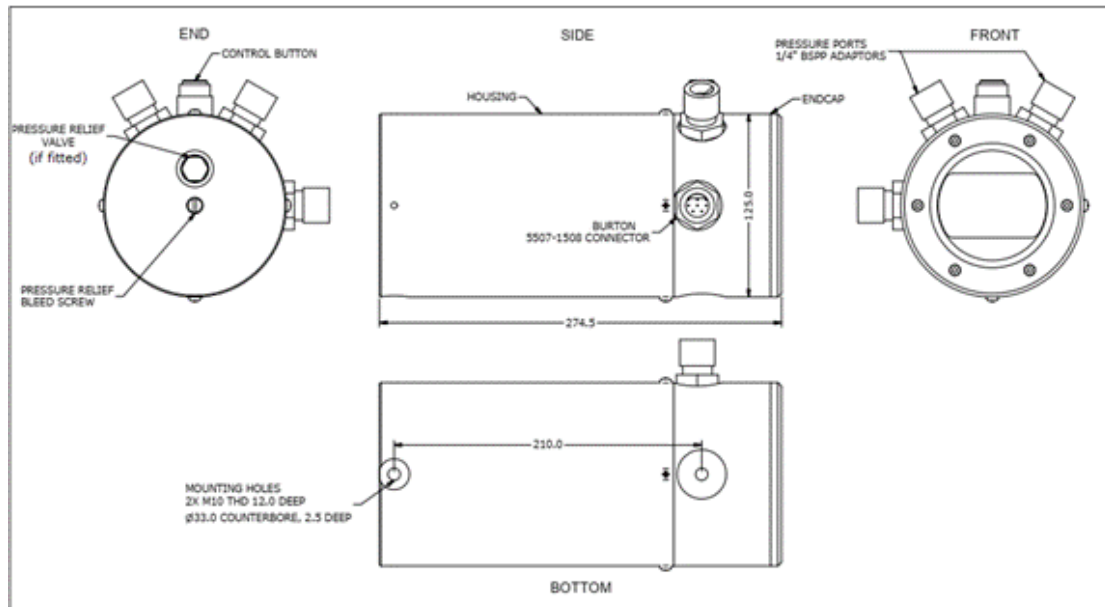

MOUNTING OPTIONS: As standard, the unit is supplied with 2x 12mm deep, M10 threads, 271 mm apart as shown above.

ADDITIONAL SENSORS: The 6001SD can be supplied with up to 2x pressure (incorporating temperature sensors in each sensor).

POWER OPTIONS: The unit can be powered from an internal battery OR an external +15V to +28V supply. The standard battery pack is made up from Alkaline cells but the unit can be powered from a Lithium pack if required to provide extended battery life, particularly at temperature extremes.

RS485 OPTION: An optional RS485 link, using dedicated software, provides download of data by ASCII or Xmodem protocol. Standard terminal software such as HyperTerminal or TeraTerm can also be used.

ACOUSTIC PINGER INTERFACE OPTION: The unit can be interfaced with a standard acoustic pinger to begin pinging, stop pinging, or change rate when a particular pressure, temperature, or time threshold is reached.

ACOUSTIC DATA TRANSDUCER INTERFACE OPTION: The unit can be interfaced with an acoustic data transducer. This allows readings to be monitored every 1 minute at a range of up to 10km.

2. SPECIFICATIONS

Below are the standard specifications for the 6001SD. Please refer to the table on the cover of this manual for the specifications of the 6001SD delivered with this manual.

GENERAL

| | |
|---|---|
| Battery life at 5°C/40°F with LOW POWER mode DISABLED | 21* days |
| Battery life at 5°C/40°F with LOW POWER mode ENABLED..... | 80* days |
| Battery voltage | 12V |
| Battery type | Alkaline pack (OEL-000469) |
| Operating temperature range..... | -5°C to +65°C/23°F to 149°F |
| Operating depth | 3000m/10,000ft* |
| Pressure range..... | 0-2000 BAR/0-30,000 psi* |
| Standard pressure sensor accuracy..... | ±0.05% FS |
| Pressure display resolution | 0.001 bar/0.01 psi* |
| Pressure connection..... | ¼" BSPP M/M ADAPTOR or Customer specified |
| Temperature sensor accuracy | ±0.5°C/ ±1.0°F |
| Temperature display resolution | 0.01°C/0.1°F |
| Weight in air | 13kg/29lb |

*Battery life for 6001SD when not powering interfaces, imperial units have been rounded for clarity, pressure range and resolution based on pressure transducers fitted.

MATERIALS:

| | |
|---------------------------|---|
| Housing material | ALLOY BRONZE CA104 EN 12163 |
| Endcap material | ALLOY BRONZE CA104 EN 12163 |
| Bleed screw material..... | ALLOY BRONZE CA104 EN 12163 |
| Window material | ACRYLIC |
| Endcap O-rings | 2x BS 50-243 NBR70 with 2x BS 250-243 PTFE BURs |
| Window O-ring | 1x BS 50-236 NBR70 |
| Bleed screw O-ring | 1x BS 50-008 NBR70 |

OPTIONS:

| | |
|--------------------------|---------------------------|
| Data communication | RS485 |
| Data format | 115200BAUD, N, 8 ,1 |
| Logging | Various regimes available |

3. RULES FOR SAFE OPERATION

⚠ WARNING: Any operation involving pressure is potentially hazardous. No person should use this equipment unless fully aware of the potential hazards of working with pressurised vessels. The purchaser of this equipment is responsible for the training and competence of operators and the manner in which it is used. This manual should be read through and understood before installation and commissioning so that the operator is familiar with the equipment. Contact IK Trax immediately should any difficulty arise in the use of this equipment.

The 6000SD may have a Pressure Relief Valve (PRV) at the bottom of the housing next to the pressure relief Bleed Screw. Should an internal pressure leak occur the PRV is configured to operate at > 5 – 10psi (>0.35 – 0.67BAR). It has a depth rating greater than that of the housing.

⚠ CAUTION: Care should be taken to ensure the PRV does not become blocked with debris.

⚠ WARNING: ALWAYS loosen the bleed screw to relieve any internal pressure prior to opening the unit.

⚠ WARNING: ALWAYS check for any signs of water ingress on retrieval after deployments. The bleed screw should be loosened and re-tightened on retrieval to ensure there has been no pressure build up in the unit during deployment.

⚠ WARNING: Always use caution when opening equipment which has been in a pressurised environment. It is possible for pressure to leak into the equipment and remain there even after external pressure has been removed. ALWAYS point the end to be opened towards a safe area and away from yourself or others. Contact IK Trax immediately if there is a suspicion that the equipment has become pressurised.

⚠ CAUTION: Opening of the equipment should take place in a clean, dry, laboratory environment.

⚠ CAUTION: To prevent the formation of condensation within the unit, allow the unit temperature to stabilise within the laboratory environment for a minimum of 6 hours prior to opening.

⚠ CAUTION: It is possible for liquids to become trapped in threads and/or gaps around openings. ALWAYS point the end to be opened downwards to allow any trapped liquid to drain out of and not into the equipment.

⚠ CAUTION: Do not expose to aggressive solvents or chemicals which could be harmful to the HOUSING, O-RINGS, CONNECTORS or any other parts of the equipment.

⚠ CAUTION: If the external connector is unused, it MUST be fitted with a suitable blanking connector (e.g. BURTON 5501-1508-0000) to prevent conduction between the pins and malfunction.

⚠ CAUTION: A protective rubber cap is fitted over the control button to prevent ingress of debris. Always ensure that after pressing the control button it returns to the un-pressed position. If required the button can be un-screwed and rinsed in fresh water to clear out any debris.

4. OPERATION

Familiarise yourself with all warnings given at the start of Section 3 RULES FOR SAFE OPERATION.

4.1. TURNING ON

To turn the unit on simply press and hold the control button until the IK Trax logo is displayed. Once the countdown appears the button can be released.

The first screen to appear after switch on is the IK Trax logo. This will be displayed for 5 seconds as shown by the COUNTDOWN INDICATOR located at the bottom left hand side of the display.

The 6001SD will carry out a self-check of the RTC circuitry and logger memory. If any problems are detected then an error message will be displayed.



The next screen is the STATUS screen. This shows the current configuration of several settings. This screen is described in section 4.2.2 STATUS followed by a test pressure status screen if enabled.

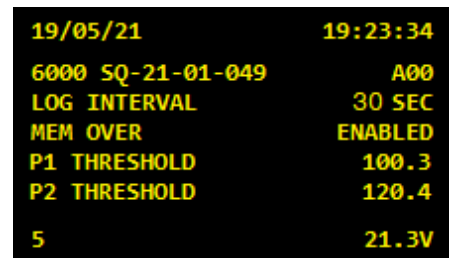

The unit then interrogates the sensors attached and displays their details. It also reads the temperature compensation from the sensors.

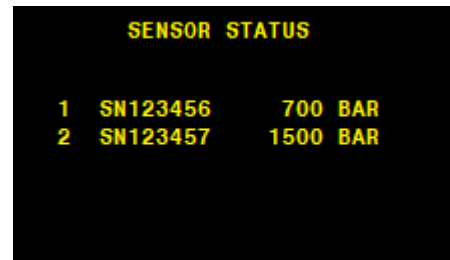

After displaying these screens the 6001SD will begin taking and displaying reading(s) from all enabled sensor(s). If the unit is configured for 30 second, 1, 2 or 5 minutes the display will show a LOG message to confirm logging at the configured LOG INTERVAL. No logging message is displayed for 1 second interval logging.

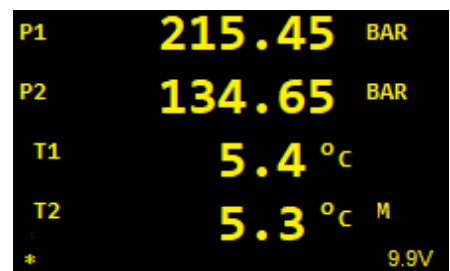

An asterisk is displayed for half a second at the bottom left of the screen when a reading is taken (not necessarily logged) by the sensor every second.

The current battery voltage is displayed at the bottom right of this screen. The battery packs should be changed if the voltage indicated is near 8V.

4.2. SINGLE BUTTON MENU INTERFACE

Refer to the figure on the following page. At any point while the 6001SD is displaying reading(s) the control button can be pressed to enter the menu interface. From the menus the user can view and change several parameters which are discussed in this section.

While in the menu system, every time the user presses the control button the CURSOR will move down one line and the COUNTDOWN INDICATOR will be reset to 5. Once the CURSOR is pointing at the desired item the user simply allows the COUNTDOWN INDICATOR to reach 0 and the selected item will be executed. This simple behaviour is used throughout the menu interface to modify settings and interact with the 6001SD unit.

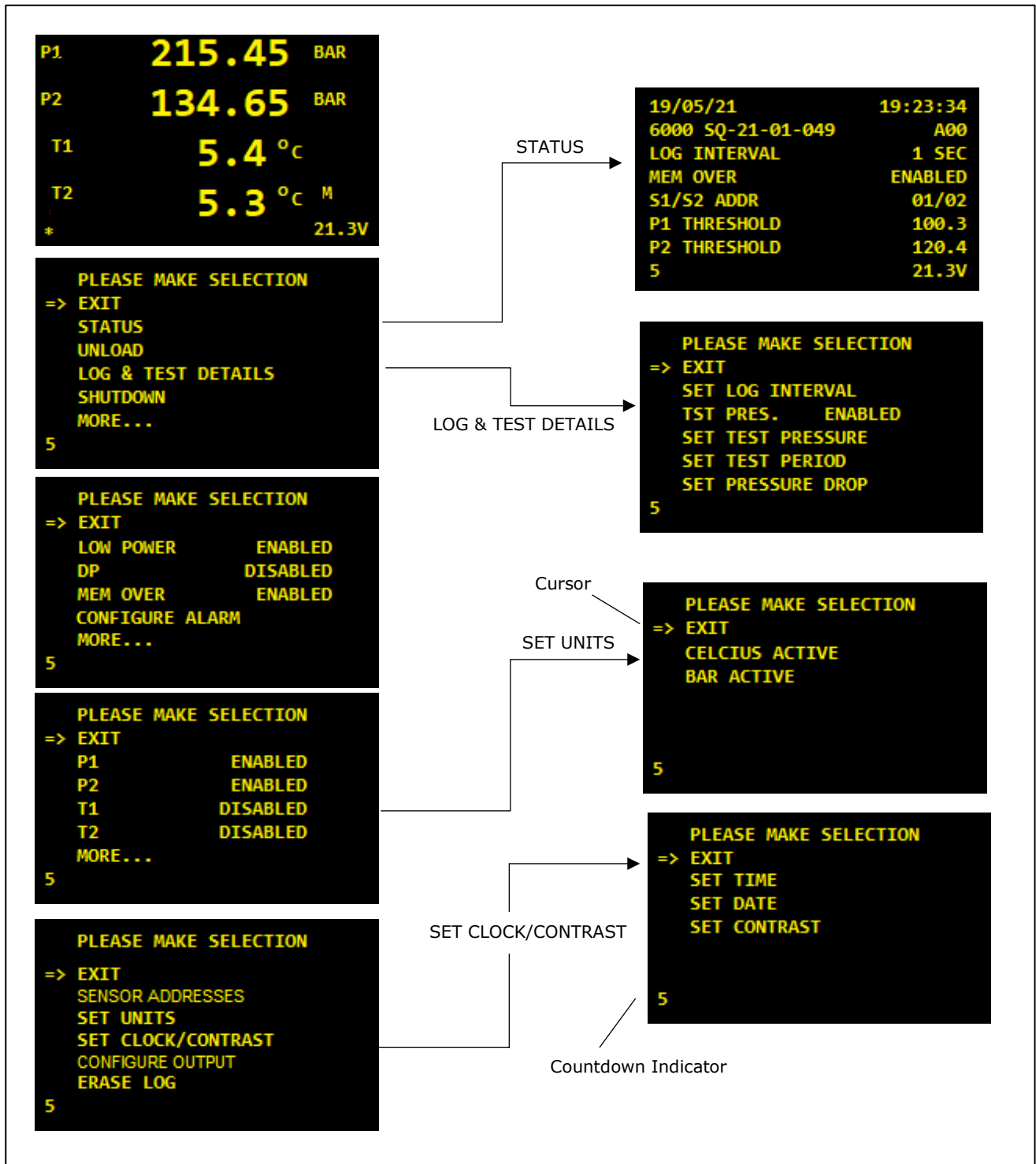

4.2.1. EXIT

Every page of the menu system starts with EXIT. If EXIT is selected then the 6001SD will exit to the previous menu screen and eventually resume taking and displaying readings from all enabled sensors. The menu system is designed so that if the control button is not pressed then the 6001SD will always exit back through the menu system and resume taking readings as normal.

4.2.2. STATUS

The STATUS screen is shown at power-up after the 6001SD logo and can also be viewed at any point by selecting STATUS from the menu system. It shows the Date, Time, Firmware type, Firmware version, Log interval, Memory overwrite setting, and Alarm configuration.

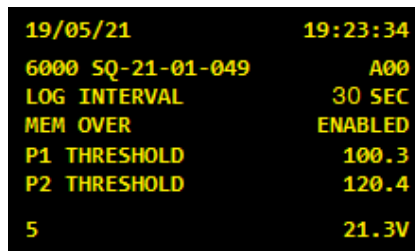

| | |
|-------------------|----------|
| 19/05/21 | 19:23:34 |
| 6000 SQ-21-01-049 | A00 |
| LOG INTERVAL | 30 SEC |
| MEM OVER | ENABLED |
| P1 THRESHOLD | 100.3 |
| P2 THRESHOLD | 120.4 |
| 5 | 21.3V |

If the TEST PRESSURE function is enabled a further LOG & TEST screen will be displayed.

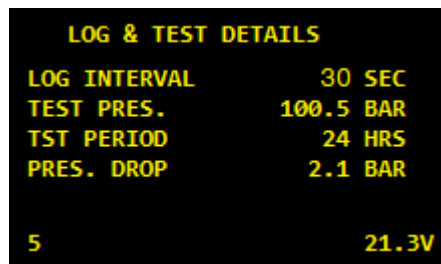

| | |
|--------------------|-----------|
| LOG & TEST DETAILS | |
| LOG INTERVAL | 30 SEC |
| TEST PRES. | 100.5 BAR |
| TST PERIOD | 24 HRS |
| PRES. DROP | 2.1 BAR |
| 5 | 21.3V |

Ensure all settings are at the required values.

4.2.3. UNLOAD

Selecting this item causes the 6001SD to unload all logged data via RS485. Refer to section 5 DATA UNLOAD for instructions regarding retrieving logged data. Selecting this item does not erase any logged data.

4.2.4. SET LOG & TEST DETAILS

Selecting this item allows configuration of logging interval, enabling of the PRESSURE TEST FUNCTION (see section 4.4) and parameters relating to the PRESSURE TEST FUNCTION.

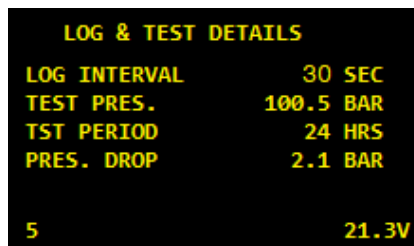

| | |
|--------------------|-----------|
| LOG & TEST DETAILS | |
| LOG INTERVAL | 30 SEC |
| TEST PRES. | 100.5 BAR |
| TST PERIOD | 24 HRS |
| PRES. DROP | 2.1 BAR |
| 5 | 21.3V |

4.2.5. SET LOG INTERVAL

Selecting this item allows the user to change the LOG INTERVAL. The LOG INTERVAL can be set to every 1 second, 30 seconds or 1, 2, 5 minutes. At each log interval the 6001SD will log the Date (DD/MM/YY), Time (HH:MM) along with data from enabled sensors. Pressure 1, Pressure 2, Temperature 1, and Temperature 2. A message as shown will also appear for approximately 2 seconds. Refer to section and section 5.3.1 LOGGED DATA FORMAT for more information. Changing the LOG INTERVAL resets both the limits and test pressure functions on return from the menu system.

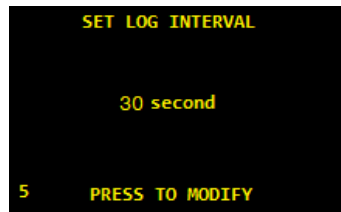

4.2.6. ENABLE/DISABLE LIMITS OR PRESSURE TEST

Toggling this item either enables/disables the Limits and/or the Test Pressure function.

- NO LIMITS/TEST PRES.
- LIMITS ENABLED
- TEST PRES. ENABLED

The LIMITS function as detailed in Section 4.3 or enables the Test Pressure function (Section 4.4).

4.2.7. SHUTDOWN

Selecting this item switches off the 6001SD. The 6001SD is fitted with non-volatile memory which will remember all settings (such as LOG INTERVAL and LOW POWER mode) made via the menu system next time the unit is switched on. It is imperative that the 6001SD unit is turned off using this command rather than simply disconnecting the battery so that any memory storage processes are allowed to terminate prior to turning OFF.

4.2.8. MORE

Selecting this item shows the next page of the menu system. Refer to the figure in section 4.2 SINGLE BUTTON MENU INTERFACE to see the menu pages and items available.

4.2.9. LOW POWER ENABLED / DISABLED

This item shows configures LOW POWER mode as ENABLED or DISABLED. If LOW POWER is DISABLED then the display is permanently on and will update readings every 1 second. If LOW POWER is ENABLED then the display turns on for 2 seconds every 15 seconds to show the sensor readings and limits display. Use of LOW POWER mode significantly increases battery life as the OLED display does consume significant current and should be selected where long term deployment and logging is required.

4.2.10. DP ENABLED/DISABLED

This item shows whether or not DP (Differential Pressure, the unsigned differential pressure between P1 and P2) is ENABLED or DISABLED. If DP is enabled then the display will replace the reading for T1 with DP. Irrespective of this setting, the logged data will be unchanged; P1, P2, T1, T2 will be logged. Note that the 6001SD does not round readings to the nearest least significant digit so the DP result may include an error of \pm the least significant digit.



4.2.11. MEM OVER ENABLED / DISABLED

This item shows configures MEMORY OVERWRITE as ENABLED or DISABLED. ENABLE MEMORY OVERWRITE to allow the logger to overwrite oldest data first should the logger memory become full. DISABLE MEMORY OVERWRITE to prevent the logger from overwriting old data should the logger memory become full.

4.2.12. CONFIGURE ALARM

The alarm function is an optional feature as it requires a suitable cable to be connected to the 6001sd.

Selecting this item allows the user to configure the alarm interface of the 6001SD. The alarm can be configured in either of two modes: DIFFERENTIAL (a single threshold value is compared against the unsigned difference between P1 and P2) or INDEPENDENT (an alarm threshold for P1 is compared against P1 and a second threshold for P2 is compared against P2). The table below shows the relevant conditions and the resultant output resistance between the GND and ALARM connections. Typically a dual rate acoustic transmitter is used as an alarm configured to transmit at a faster rate if the output resistance is >1MΩ or at a slower rate if output resistance is 1kΩ.

| MODE | PRESSURE & THRESHOLD | OUTPUT |
|--------------|--------------------------------|--------|
| DIFFERENTIAL | P1 - P2 < THRESH | >1MΩ |
| DIFFERENTIAL | P2 - P1 < THRESH | >1MΩ |
| DIFFERENTIAL | P1 - P2 > THRESH | 1kΩ |
| DIFFERENTIAL | P2 - P1 > THRESH | 1kΩ |
| INDEPENDENT | P1 < THRESH1 AND P2 >= THRESH2 | >1MΩ |
| INDEPENDENT | P1 >= THRESH1 AND P2 < THRESH2 | >1MΩ |
| INDEPENDENT | P1 < THRESH1 AND P2 < THRESH2 | >1MΩ |
| INDEPENDENT | P1 > THRESH1 AND P2 > THRESH2 | 1kΩ |

To disable the alarm on a sensor, disable the sensor using the OLED menu or configure a suitably high threshold. While in DIFFERENTIAL mode both sensors must be enabled.

While in LOW POWER mode is DISABLED the alarm state is checked every 1 second. While LOW POWER mode is ENABLED the alarm state is checked every 15 seconds.

4.2.13. SENSOR ENABLED / DISABLED

These menu items show the status of each sensor and allow the user to ENABLE or DISABLE sensors. As standard the 6001SD is fitted with a single pressure and temperature sensor with address 01. A second pressure and temperature sensor can be fitted and is given the address 02 as standard. If a sensor is disabled then '----.---' will be displayed and no reading will be logged by the 6001SD.

4.2.14. SENSOR ADDRESSES

As standard the 6001SD is configured for two digital pressure and temperature sensors with addresses 1 & 2. These addresses must be programmed into the digital pressure sensors. This can either be done using the digital pressure sensor manufacturers configuration software or using this menu item. Along with the address the sensors must be configured to communicate at 115200 BAUD. Communications with the sensors use MODBUS RTU protocol over RS485.

If new sensors need to be configured using the 6001 (as opposed to the sensor manufacturer software) then only one sensor can be connected to 6001 at a time to be configured.

To program a sensor:

- Disconnect all sensors from the Dual Data Pod
- Connect the sensor to be configured
- Select SETUP SENSORS menu item
- Select the sensor to be configured

- The 6001 will try and communicate with the sensor attached.

- If successful it will display SENSOR DETECTED, PROGRAMMING, CHECKING and finally PROGRAMMED.

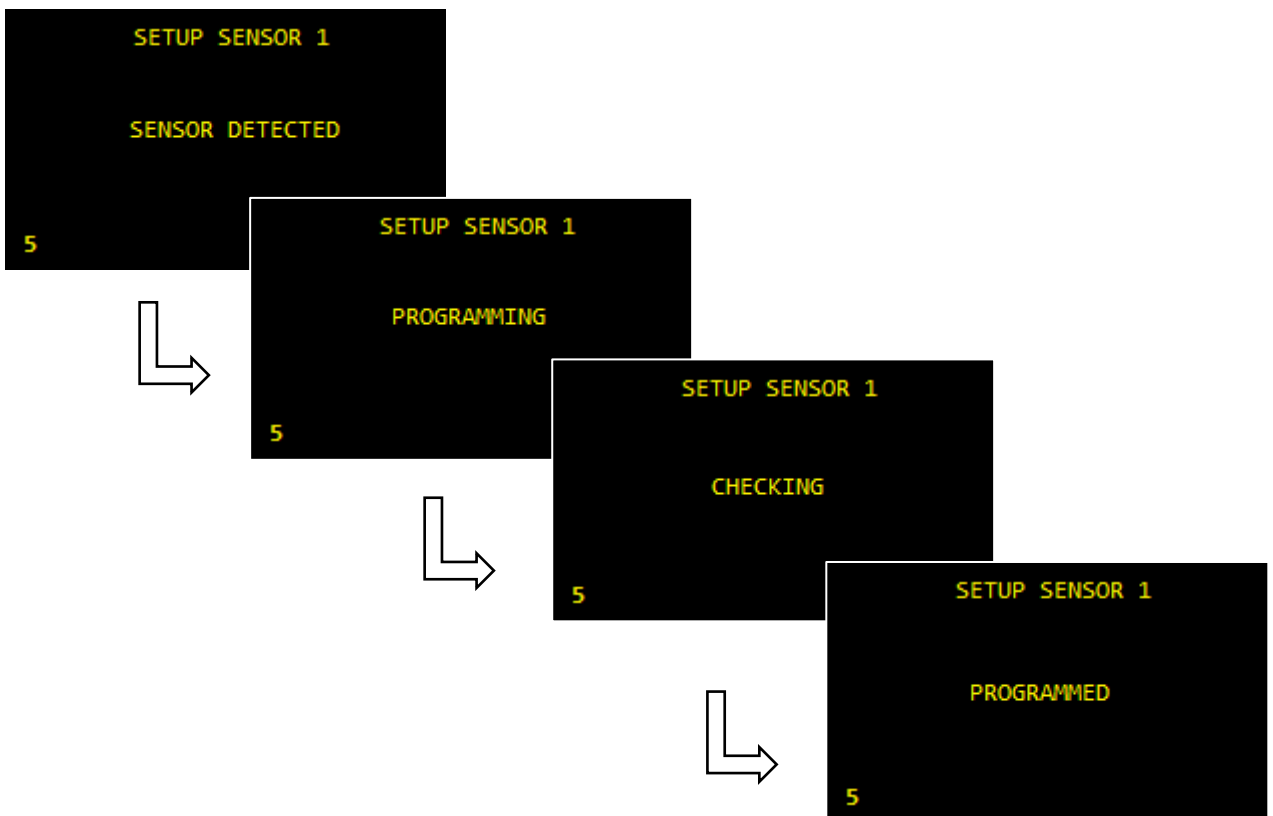
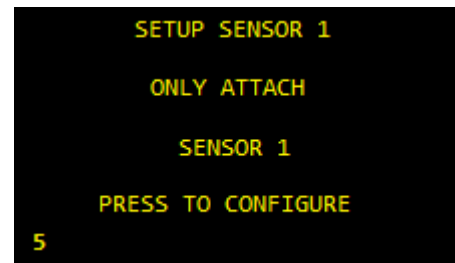
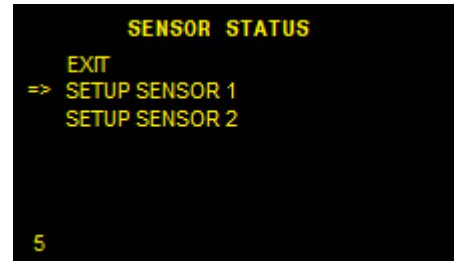

- If more sensors require configuration, then disconnect the sensor just programmed and repeat for each sensor.
- Once all sensors are programmed they can be attached to the cables in the required order.

4.2.15. SET UNITS

This item allows the user to set both the units used for pressure (bar or psi) and temperature (Celsius or Fahrenheit) to be selected.

To view or change settings, select this item. On the following screen select the units desired.

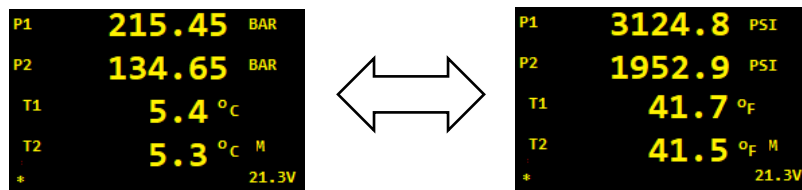

4.2.16. SET TIME & DATE

Enters further menu to allow time and/or date to be set. Follow the instructions given on screen to modify this value.

4.2.17. SET TIME

This item allows the user to set the internal time which is logged with each reading. Follow the instructions given on screen to modify this value.

4.2.18. SET DATE

This item allows the user to set the internal date which is logged with each reading. Follow the instructions given on screen to modify this value. Ensure a valid date is used, for example February does not have 31 days.

4.2.19. SET CONTRAST

This item allows the user to set the contrast, brightness, of the display. As with LOW POWER mode this can significantly improve battery lifetime and should be set to an acceptable level for clarity in order to aid this.

4.2.20. CONFIGURE OUTPUT

The 6001SD can output data via the RS485 connection or to a pinger configured as a modem.

OUTPUT ENABLED configures the 6001SD to output pressure and temperature readings every second.

OUTPUT DISABLED disables the output of pressure and temperature.

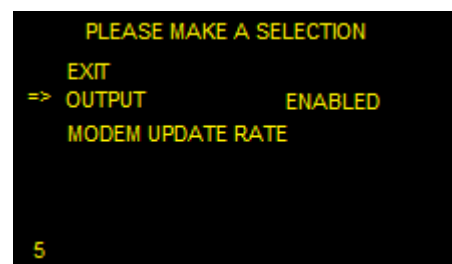

Selecting MODEM UPDATE RATE allows the selection of a pre-configured list of update times at which data is output to a connected pinger. Selecting 0 minutes disables the transmission of data to a pinger.

There is only one communications port in the 6001SD so careful consideration is required when equipment or connections are made to the 6001SD for the purposes of remotely receiving data.

If no communications are required it is advisable to select OUTPUT DISABLE and to set the MODEM UPDATE RATE to zero minutes. No data will be output on the RS485 or MODEM interfaces.

If connection to a pinger is required the OUTPUT DISABLE should be selected and the required output interval selected in order to enable the communications to the pinger.

If the output of pressure and temperature readings is required then OUTPUT ENABLE should be selected and MODEM UPDATE RATE set to zero minutes.

If output using the XMODEM protocol and then it is likely that no other output is allowed. If this feature is required then OUTPUT DISABLED may be selected and MODEM UPDATE RATE should be set to zero minutes.

4.2.21. ERASE LOG

Selecting this item will erase all logged data once the user has been prompted to confirm. Configuration settings remain unchanged. Ensure that any important data has been unloaded and saved before selecting this item.

It is advisable to UNLOAD and save previous logged data and then ERASE the log prior to each deployment to ensure the log does not overflow and data is possibly lost.

4.3. LIMITS DISPLAY

If the TEST PRESSURE FUNCTION is disabled then every minute the LIMITS DISPLAY shown will appear for approximately 2 seconds.

| | | | |
|-----|--------|------------|-----------|
| P1 | 121.45 | 122.34 BAR | } 24 HOUR |
| P2 | 132.56 | 145.67 BAR | |
| T1 | 5.6 | 5.8 °C | } 48 HOUR |
| T2 | 5.4 | 5.8 °C | |
| P1* | 125.45 | 128.65 BAR | |
| P2* | 132.56 | 152.89 BAR | |
| T1* | 5.6 | 5.8 °C | |
| T2* | 5.4 | 5.8 °C | |
| | MIN | MAX | |

The top set of readings show the maximum and minimum readings logged within the last 24 hours or since the last LIMITS RESET (if LIMITS RESET occurred within the last 24 hours).

The bottom set of readings show the maximum and minimum readings logged within the last 48 hours or since the last LIMITS RESET (if LIMITS RESET occurred within the last 48 hours).

A LIMITS RESET occurs every time the unit is turned ON, the LOG is ERASED, or the LOG INTERVAL is changed.

Note that the LIMITS DISPLAY will not appear until at least one log has occurred since the last LIMITS RESET. An asterisk is displayed against a row of readings until all readings in the interval have been gathered.

The LIMITS DISPLAY ignores disabled sensors and sensors returning errors.

4.4. PRESSURE TEST FUNCTION

The PRESSURE TEST FUNCTION allows analysis of logged data obtained during pressure tests by the 6001SD.

Readings are logged at LOG INTERVAL (Section 4.2.5 SET LOG INTERVAL).

The PRESSURE TEST FUNCTION is enabled by toggling PRES. DISABLED so that it shows PRES. ENABLED.

When enabled the menu system will show additional items allowing access to test pressure settings as shown in the figure below.

```

PLEASE MAKE SELECTION
=> EXIT
SET LOG INTERVAL
TEST PRES.      ENABLED
SET TEST PRESSURE
SET TEST PERIOD
SET PRESSURE DROP
5
    
```

The PRESSURE TEST FUNCTION, when enabled, examines the data logged data for both pressure sensors obtained in the last TEST PERIOD hours of logged data. TEST PERIOD can be set from 1 to 60 hours.

The following items are examined and checked for all the readings found in the log for the TEST PERIOD hours configured:

- Logged data exists \geq TEST PERIOD
- Pressure logged \geq TEST PRESSURE
- Difference between maximum and minimum pressure \leq PRESSURE DROP

If all of the above checks are valid then the time & date of pass is displayed.

Values for TEST PERIOD, TEST PRESSURE & PRESSURE DROP are configured by selecting the appropriate item in the menu shown in the figure above.

If there is insufficient logged data to provide this information (unit has been powered up less than TEST PERIOD hours) the TEST FUNCTION will return fail indicated by no time or date on the screen.

Every minute a screen similar to the figures below following LIMITS screen will be displayed.

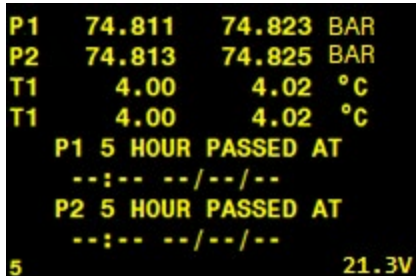

```
P1 74.811 74.823 BAR
P2 74.813 74.825 BAR
T1 4.00 4.02 °C
T1 4.00 4.02 °C
P1 5 HOUR PASSED AT
--:-- --/--/--
P2 5 HOUR PASSED AT
--:-- --/--/--
5 21.3V
```

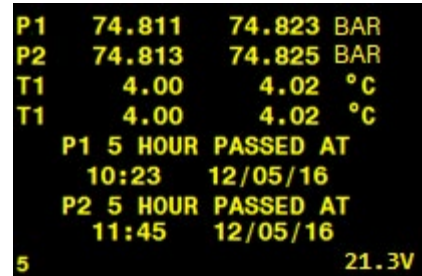

```
P1 74.811 74.823 BAR
P2 74.813 74.825 BAR
T1 4.00 4.02 °C
T1 4.00 4.02 °C
P1 5 HOUR PASSED AT
10:23 12/05/16
P2 5 HOUR PASSED AT
11:45 12/05/16
5 21.3V
```

The first example figure above shows that the pressure test failed for both pressure sensors as there is no time or data information displayed.

The second example figure shows that the pressure test passed for both pressure sensors. Sensor P1 passed at 10:23 on 12/5/2016 whilst P2 passed at 11:45 on 12/5/2016.

If the PRESSURE FUNCTION returns a pass then the time/date is updated with the new time/date continuously.

If the PRESSURE FUNCTION returns a fail then any existing pass details are held.

The PRESURE FUNCTION is reset when the unit is powered down/up but the logged data is still available until the log is erased.

N.B

It is imperative that the operator sets the correct time and date before mobilising the unit (Section 4.2.16 SET TIME & DATE).

The operator must record the time & date at which the hydro-test was deemed to have commenced.

4.5. RAM ERROR

The 6001SD contains a coin cell (BR2032) used to permanently power the Real Time Clock circuitry which stores the date and time as well as other system variables such as LOW POWER mode while the unit is turned OFF.



At switch ON the 6001SD conducts a self-check on the RTC circuitry as per section 4.1 TURNING ON. If any problems are found then the error message shown will be displayed and the 6001SD will reset all system variables to default values. Please contact IK Trax if you see this message. The most likely cause is that the coin cell has expired. See section 12.3, ROUTINE MAINTENANCE AND STORAGE, for more information.

Note that if the unit has detected a problem and has reset to default values (shown below) then an UNLOAD will result in the entire logger memory unloading and any blank areas in the memory will contain 'Fs' instead of numerical data.

| | |
|------------------|------------|
| P1 | ENABLED |
| P2 | ENABLED |
| T1 | ENABLED |
| T2 | ENABLED |
| MEM OVERWRITE | ENABLED |
| LOW POWER MODE | ENABLED |
| DP READING | ENABLED |
| LOG INTERVAL | 05 minutes |
| LIMITS | ENABLED |
| ALARM THRESHOLDS | 000.0 bar |
| CONTRAST | Level 4 |

4.6. MEMORY FULL

At switch ON the 6001SD conducts a self-check on logger memory as per section 4.1 TURNING ON. If the logger memory is found to be full then the message shown will be displayed.



If MEMORY OVERWRITE is DISABLED and the logger memory is FULL then the logger will not log any new readings and this error message will be shown every time the logger attempts to log.

If continuous logging is required the memory should either be erased as per section 4.2.21 and/or MEMORY OVERWRITE should be ENABLED as per section 4.2.11 MEM OVER ENABLED / DISABLED.

5. DATA UNLOAD

5.1. LOGGING CAPACITY

The 6001SD unit is fitted with 32 Mbytes of internal memory available for logging allowing it to store over 2,000,000 readings. This equates to a logging capacity of over 23 days logging every second, or over 3 years logging every minute. If the logging memory becomes full then it automatically wraps around and begins overwriting the oldest data first.

The 6001SD unit can take a significant amount of time to transmit all logged data depending on how much data has been stored. Unloading the entire memory can take up to 60 minutes and the resultant *.txt file size will be many megabytes.

5.2. 6000 XMODEM UNLOAD SOFTWARE

To speed up data download due to the increased flash memory in the 6001SD (necessitated by the requirement for logging every second) a new 6000 UNL application has been created. This is based on XMODEM file transfer protocol which provides robust half duplex communication and downloads the data in binary rather than text format.

The 6001SD is intended to be interfaced to a Hydromea LUMA 250LP optical modem subsea via OEL-006648 cable which has a Burton 1508 and MCIL6F connector to allow connection to the 6001SD and the LUMA 250LP MCIL6 M tail.

An additional USB-Burton 1508 download cable has been provided for download when the unit is retrieved or tested topside.

1. For download topside or for testing connect the USB end of the 6000SD download cable to the PC and the Burton end of the 6001SD download cable to the 6001SD unit.
2. Referring to the figure below, open the software and select the COM port which the 6000SD USB download cable is connected to in the 'Available COM Ports' drop down menu. If the correct COM port number is not known then each available COM port can be tried in turn until the correct one is found or the correct COM port can be identified from the Device Manager within windows (right click on My Computer> Properties> Device Manager).

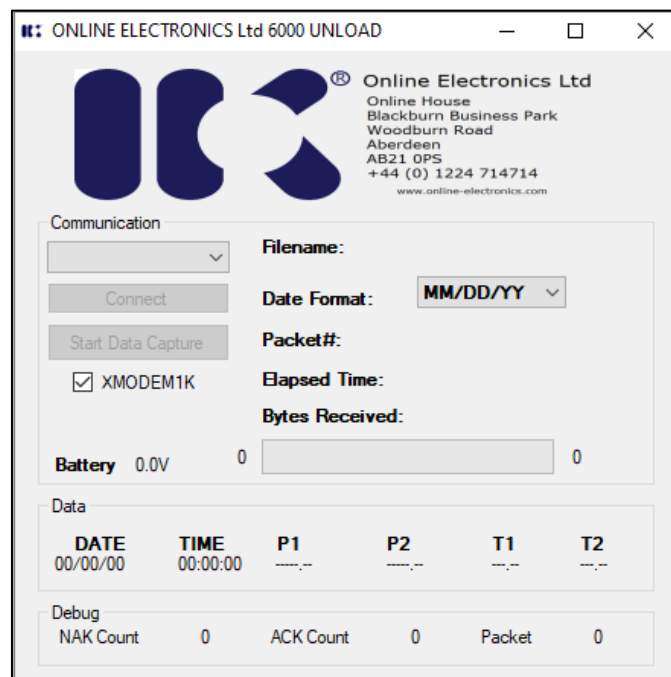

3. For topside download turn the 6001SD unit ON by pressing and holding the control button until the IK logo appears on the display.
4. Press the 'Connect' button to connect to the 6001SD unit.
5. The tick box XMODEM1K enables transmission of 1 kilobyte blocks of data. If un-ticked the block size is 128 bytes and will take considerably longer to download data but may aid reliable transmission in difficult conditions (with reference to using the optical modem).
6. Press the 'Start Data Capture' button and a directory window will appear. Ensure that the location is somewhere easy to find such as the Documents. Captured data will be saved with filename '6000SD DATA YYMMDD HHMMSS.CSV'.
7. Once a file location has been confirmed the application communicates with the 6001SD. Whilst downloading data no readings are taken or logged. The 6001SD will display 'XMODEM Unload'.
The 6001SD unit will handshake the data via the LUMA 250LP modem or download cable. During the download the packet count received will increment along with a progress bar showing the progress of the download with the total number of bytes expected. The transfer process can take up to 60 minutes, depending on how much data has been logged. The process can be terminated at any point by pressing the Stop Data Capture button.
8. A message will be displayed if the download is successful or if the download is stopped. The download may display TIMEOUT if too many errors are encountered in which case the LUMA 250LP modem link should be investigated. After completion or if 'Stop Data Capture' button within the software to save the logged data to the '6000SD DATA YYMMDD HHMMSS.TXT' file.
9. Open the '6000SD DATA YYMMDD HHMMSS.CSV' file and ensure that the required data has been stored. Note the 'csv' file created may be too large for MSEXCEL to handle and may require an alternative application to be used for analysis.
10. If the unit has been retrieved the data on the 6001SD unit can be erased by selecting the ERASE LOG option within the 6001SD display menu. This means there will be less data to unload next time.
11. Press the 'Disconnect' button to disconnect from the 6001SD unit and then exit the software.
12. Always disconnect the 6001SD download cable from the 6001SD when not in use. In particular never leave the download cable connected to the 6001SD while the USB end is not connected to a PC or the PC has been turned off.

5.3. UNLOAD DATA OUTPUT

Data can be downloaded using the UNLOAD function in the menu system.

1. Connect the USB end of the 6001SD download cable to the PC and the Burton end of the 6001SD download cable to the 6001SD unit.
2. The 6001SD unit transmits logged data in ASCII format at 115200 baud, 8 Data bits, No parity, 1 Stop bit, and with No Flow control. Any terminal program such as HyperTerminal or TeraTerm configured with these settings can be used to receive the logged data if required
3. Turn the 6001SD unit ON by pressing and holding the control button until the IK logo appears on the display.
4. On the 6001SD unit itself, select UNLOAD from within the display menu. The 6001SD unit will transmit the word 'START' to the PC, followed by all logged data, followed by the word 'STOP'. There may be a delay between the 6001SD sending all data and the software receiving all data. To avoid disturbing the process do not use the PC until all logged data has been received. The transfer process can take up to 15 minutes depending on how much data has been logged. The process can be terminated at any point by pressing the 6001SD control button once.
5. At this point the data on the 6001SD unit can be erased by selecting the ERASE LOG option within the 6001SD display menu. This means there will be less data to unload next time.
6. Always disconnect the 6001SD download cable from the 6001SD when not in use. In particular never leave the download cable connected to the 6001SD while the USB end is not connected to a PC or the PC has been turned off.

5.3.1. LOGGED DATA FORMAT

A single reading is stored in 6 columns representing Date, Time, Pressure 1, Pressure 2, Temperature 1, and Temperature 2 respectively:

```
DD/MM/YY <SP> HH:MM:SS <TB> P1 <TB> P2 <TB> T1 <TB> T2 <CR> <LF>
```

Where <TB>, <SP>, <CR>, and <LF> represent 'Tab', 'Space', 'Carriage Return', and 'Line Feed' characters respectively. This data can be pasted directly into a spreadsheet for analysis and/or for generating graphs. All pressure values are logged in 123.123 format and all temperature values are logged in 12.12 format.

If an enabled sensor has been disabled, disconnected, has the incorrect address, or has malfunctioned then the sensor reading output will be replaced with dashes. Ensure that the sensor is connected and that the address shown on the STATUS screen matches the address marked on the sensor itself. Also ensure that the 6001SD download cable is never left attached to the 6001SD when the USB end is disconnected or connected to a PC which has been turned off.

6. BATTERY REMOVAL

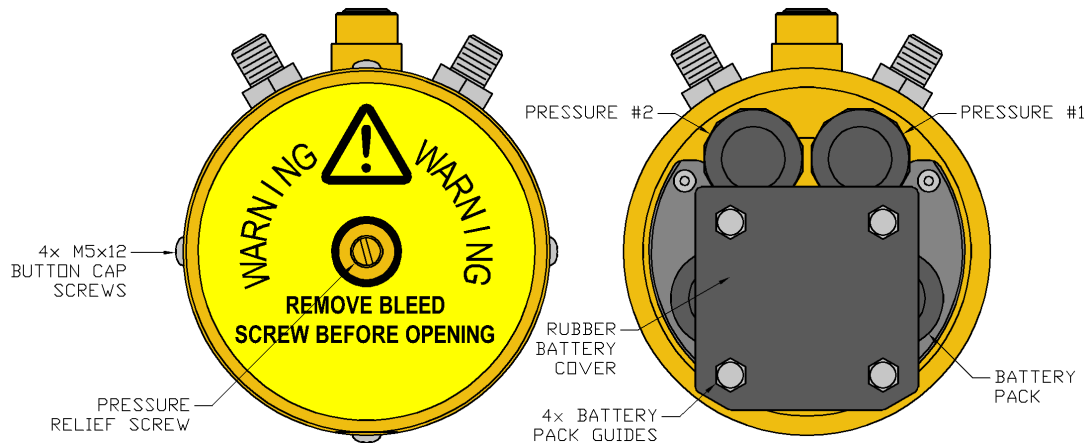

1. Opening of the unit should only take place in a clean, dry, laboratory environment.
2. To prevent the formation of condensation within the unit allow the unit to stabilise within the laboratory environment for a minimum of 6 hours prior to opening.
3. Loosen the bleed screw to relieve any internal pressure.
4. Remove the 4x M5 screws around the perimeter of the housing.
5. Carefully remove the housing from the endcap. Ensure that the o-ring seals are protected from damage and contamination while the unit is open.
6. The 6001SD is fitted with a single battery pack (12V Alkaline pack (OEL-000469).
7. Ensure the unit is turned OFF before disconnecting each battery connector. Replace the batteries. Ensure all wires are installed neatly and protected from accidental damage.
8. Examine the O-ring seals for any signs of damage or contamination. Replace if necessary. Ensure the spiral tails of the Back-Up Rings do not protrude from the assembly before fitting the Endcap. These can be secured in place with silicone grease.
9. Reassemble the unit following the above instructions in reverse.
10. Tighten the bleed screw.

6.1. BATTERY LIFETIME

As with all battery powered equipment the operating temperature which the 6001SD is used at alters the operating lifetime. Typically colder temperatures shorten the lifetime. For the standard Alkaline pack the lifetime at +20°C will typically be 20% more than the lifetime at +5°C. Please contact IK Trax for more details or to discuss your requirements.

The combination of the 2 off alkaline battery packs should produce a nominal terminal voltage of around 22.5V.

The end point of battery life is normally considered to be 1.0V per cell. Given there are 15 off cells in total, in the 2 off battery packs used, then the battery packs should be changed if the voltage displayed is near 15V.

7. SOFTWARE INSTALLATION

There are three stages to the software installation. Instructions for each stage are given below.

7.1. MICROSOFT .NET FRAMEWORK INSTALLATION

The software supplied by IK Trax requires the Microsoft .NET Framework to be installed on the host PC. For more information about the .NET, or to download the latest version, visit www.microsoft.com/net. The latest version can also be found on the software CD supplied by IK Trax and can be installed by following the instructions below.

1. Log into the host PC as an administrator with full administrator rights.
2. Execute the dotNetFx40_Full_x86_x64.exe file found in the .NET folder on the CD.
3. Follow all instructions provided on screen to complete the installation.

7.2. 6001SD SOFTWARE INSTALLATION

The 6001SD unit transmits data in ASCII or binary format at 115200 baud, 8 Data bits, No parity, 1 Stop bit, and with No Flow control. Any terminal program such as HyperTerminal or TeraTerm configured with these settings can be used to receive the logged data.

To install the 6001SD_3102 software supplied by IK Trax follow the instructions below.

1. Log into the host PC as an administrator with full administrator rights.
2. Execute the setup.exe file found in the 6001SD_3102 software folder on the USB thumb drive.
3. Follow all instructions provided on screen to complete the installation.
4. The software will now be available in the Start Menu directly or via a sub-directory on the Start Menu.

7.2.1. USB-RS485 DRIVER INSTALLATION

The 6001SD download cable includes a USB to RS485 converter which requires VCP (Virtual COM Port) drivers to be installed on the host PC. For more information, or to download the latest version, visit www.ftdichip.com/FTDrivers.htm. The latest driver version can be found on the software CD supplied by IK Trax and can be installed by following the instructions below.

1. Log onto the host PC as an administrator with full administrator rights.
2. Connect the USB to an available USB port on the host PC. If windows does not already have suitable drivers installed it will automatically detect the device and prepare to install drivers.
3. When prompted to, point windows towards the RS485 DRIVERS folder on the CD.
4. Follow all instructions provided on screen to complete the installation.

8. EXTERNAL CONNECTIONS

**THE 6001SD SQ-21-01-049 IS NOT CONFIGURED FOR EXTERNAL POWER.
DO NOT CONNECT EXTERNAL POWER AS THIS WILL RESULT IN PERMANENT DAMAGE.**

The unit is fitted with a Burton 5507-1508, 8 way, bulkhead connector to provide connection to external power, communications, and other interfaces the standard connections will be as shown below. Attaching external power without having the unit reconfigured will result in permanent damage.

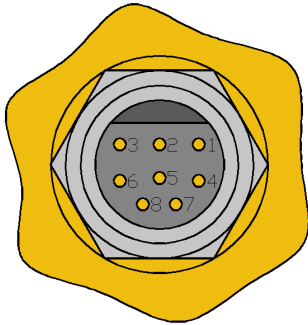

BURTON 5507-1508 BCR MATING FACE

| SIGNAL | BURTON CONNECTION |
|---------------|-------------------|
| GND | 1 |
| MODEM | 2 |
| NO CONNECTION | 3 |
| RS485A(-) | 4 |
| SWITCH | 5 |
| RS485B(+) | 6 |
| NO CONNECTION | 7 |
| ALARM | 8 |

9. CALIBRATION

The accuracy of the 6000SD sensors can be checked at any point by applying a known reference pressure and/or temperature to the sensors and recording the reading returned by the 6000SD. Calibration of the 6000SD itself is not required.

IK Trax can supply replacement calibrated sensors which can be fitted to the unit in the field. Refer to Section 9.3 SENSOR REPLACEMENT for correct re-installation of the sensors.

9.1. PRESSURE SENSOR CALIBRATION

If the 6000SD is to be submitted for re-calibration of its sensors it is recommended that the pressure test is carried out via the required BSPP port on the housing using suitably rated hose connections.

If a sensor is removed for calibration then reference Section 9.3 SENSOR REPLACEMENT for re-assembly.

After calibration a pressure test should be conducted via the pressure ports on the 6000SD at full pressure to confirm the integrity of the sensor assembly. This should be done with the battery end cap removed so the integrity of the seal(s) can be confirmed.

9.2. TEMPERATURE CALIBRATION

As standard the unit is calibrated at 3x points: +0°C, +15°C, and +30°C at atmospheric pressure. The sensors are adjusted to be within $\pm 0.2^\circ\text{C}$ at each point. Application of significant pressure can alter the temperature reading, total temperature error is $\pm 0.5^\circ\text{C}$ from +0°C to +30°C.

The pressure transducers contain a temperature sensor which is used to monitor temperature. Temperature calibration is performed by removing the pressure transducer and applying the required 3 reference temperatures in conjunction with calibration software supplied by IK Trax.

9.3. SENSOR REPLACEMENT

1. Familiarise yourself with all warnings given in Section 3 RULES FOR SAFE OPERATION.
2. Following the instructions described in Section **Error! Reference source not found.** BATTERY REMOVAL open the unit.
3. The sensors are then visible and accessible as shown in the image from Section **Error! Reference source not found. Error! Reference source not found..**
4. Unscrew the plastic end from each sensor to expose the electrical connection.
5. Carefully pull out the electrical connection.
6. Use a 27mm spanner to unscrew each sensor.
7. Each new sensor should be clearly marked with an address 01, 02, 03 or 04. The 6000 can be reconfigured to point the relevant address to the required P1/T1 or P2/T2 as per Section **Error! Reference source not found. Error! Reference source not found.** of this manual.
8. Make sure that the 6000 sealing faces are undamaged and thoroughly clean with no grease and free from dirt etc.
9. For sensors requiring copper sealing washers refer to Section 9.4 PRESSURE SENSOR SEALING WASHERS.
10. Screw in the new sensors.
11. Refit the electrical connection carefully noting that there is a small tab to indicate correct orientation. It does not matter which electrical connection goes to which sensor since the sensors are addressed on an RS485 BUS.
12. Refit the plastic end to each sensor which provides strain relief.

13. Temporarily switch the unit on, reconfigure sensor addressed if required as per Section **Error! Reference source not found. Error! Reference source not found.** and confirm that valid readings are received.
14. Reassemble the unit following the instructions as detailed in Section **Error! Reference source not found. Error! Reference source not found.**
15. Temporarily switch the unit on again to reconfirm function.

9.4. PRESSURE SENSOR SEALING WASHERS

Pressure sensors >1000BAR use copper sealing washers. If a sensor is removed, for whatever reason, the copper sealing washer should be replaced by a new unused washer, as these type of washers can only be used once.

It is recommended that only the following sealing washer is used (as recommended by Keller):

SERCO SO40007-1/4 Man. No. 016.0070.040

For all pressure transducer types the 6000SD sealing surface should be clean the sensor tightened to 20 – 25Nm (15-19 ft lbs), as recommended by Keller, for all pressure sensor types.

10. OPTIONAL ACCESSORIES

10.1. ROV SWITCH OPTION

The ROV switch behaves in an identical way to the manual control button. The unit is always fitted with a control button. When fitted with an ROV switch, either the control button or the ROV switch can be used to control the unit.

The ROV switch is a robust, rotary switch which can be rotated indefinitely in either direction. The switch contact closes when in the ON position (see figure below) and will open after turning the switch approximately 45° in either direction. When not in use the ROV switch should be rotated 180° away from the ON position to prevent accidental activation, it may also be fixed in this position with a plastic tie wrap using the 'locking' hole provided.

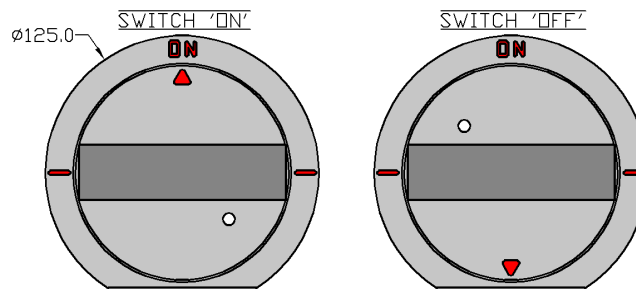

10.2. ACOUSTIC MODEM OPTION

The unit can be interfaced with an acoustic pinger data modem. In the standard configuration (every 1 minute) the unit will transmit a 6 digit number using the pinger modem representing the current P1 reading in millibar (for example, the number 031345 represents 31.345 barg).

Using an acoustic receiver, this acoustic signal can be monitored at a ranges of up to 10km depending on the condition of the acoustic path.

The 1200 series pingers also have the functionality of a regular dual rate acoustic alarm so background ping rates (in addition to the modem data) can be configured so that if a pre-defined pressure threshold is crossed the pinger will immediately change background ping rate.

10.3. OPTICAL MODEM OPTION

The 6001SD SQ-21-01-049 provides an interface by cable OEL-006648 to a Hydromea LUMA 250LP optical data modem. The interface uses RS485 communications at 115200BAUD, N, 8, 1 format.

The LUMA 250LP modems have been marked 'ROV' and '6001SD'.

The unit marked '6001SD' should be connected to 6001SD via the OEL-006648 cable.

The unit marked 'ROV' should be interfaced to the ROV communications port.

Both LUMA 250LP units have been configured using Luma Configuration Utility 250LP software with:

| LUMA Configuration Parameter | Value |
|-------------------------------------|--------------|
| Serial Baud Rate | 115200 |
| Optical Baud Rate | 250000 |
| Max. Packet Size | 64 |
| Data Wait Time | 1000 |
| Bi-Directional Gap | 0 |
| Forward Error Correction | None |
| Packet Transmit Mode | 4.1 |
| Transmit Power | 3 |

These values can be adjusted by the user although some advice from IK Trax or Hydromea may be sought.

The 6001SD is battery powered and to maximise battery lifetime, given the significant time that may be required to download data, the Transmit Power should be reduced to a value which provides reliable communication whilst keeping power drain to a minimum.

To aid battery life the Luma 250LP connected to the '6001SD' has been configured with an AUTO SLEEP DELAY of 60 seconds and the Luma 250LP connected to the ROV has been configured for BEACON MODE of 20 seconds. This means that if no beacon signal is received from the Luma 250LP connected to the ROV the modem connected to the 6001SD will go into a very low power sleep mode conserving battery power until needed. It should be noted that light sources present during sleep mode (ROV lights etc.) may partially wake up the modem causing it to draw higher currents.

During retrieval of data subsea the LUMA 250LP on the ROV should be switched on. On switch on it will then start to transmit beacon signals every 20 seconds (or as configured). Once both modems are in range the modem connected to the 6001SD will wake up and start consuming power. There is no indication provided of exit from SLEEP MODE although if communications are started (using the 6000_3102 UNL software) then the modems will start to communicate.

It is therefore possible to drain the battery of the 6001SD if other light sources are bright enough to cause it to come out of sleep mode.

See section 5.2 6000 XMODEM UNLOAD SOFTWARE for detail of using the software.

11. DEPLOYMENT CONSIDERATIONS

The following section does not provide a comprehensive deployment procedure as every deployment is different; however it does outline the most important considerations when deploying the 6001SD and should be read and understood well in advance of deployment.

At least 24 hours prior to deployment any personnel who will be involved with the operation of the 6001SD should review this entire manual to familiarise themselves with the unit. They should also be allowed time to operate the unit on deck. Simply allowing personnel to 'play' with the unit before it is actually deployed can save significant costs compared to deploying the unit without understanding how it works and then suffering from an unnecessary operator error.

IK Trax recommend fitting new battery packs before each deployment to ensure longest possible lifetime should the job be unexpectedly extended.

Turn the unit on and confirm that it is configured as required and functioning. Check that the unit is logging data and the data can be unloaded successfully.

Ensure that any unused connectors are suitably blanked (e.g. with Burton #5501-1508-0000) to prevent conduction between pins and malfunction when submerged in saltwater.

11.1. MOUNTING

The two main options for mounting are described and illustrated in the Figure below.

STRAP MOUNTED – The 6000 is provided with a Delrin mounting plate which allows ratchet straps or banding to be used to clamp the unit onto a pipeline or other infrastructure.

DEPLOYMENT CRADLE – The 6000 is provided on a custom cradle manufactured to customer specifications. This cradle may include additional equipment such as the ROV switch, flashing strobe, acoustic transmitter etc.

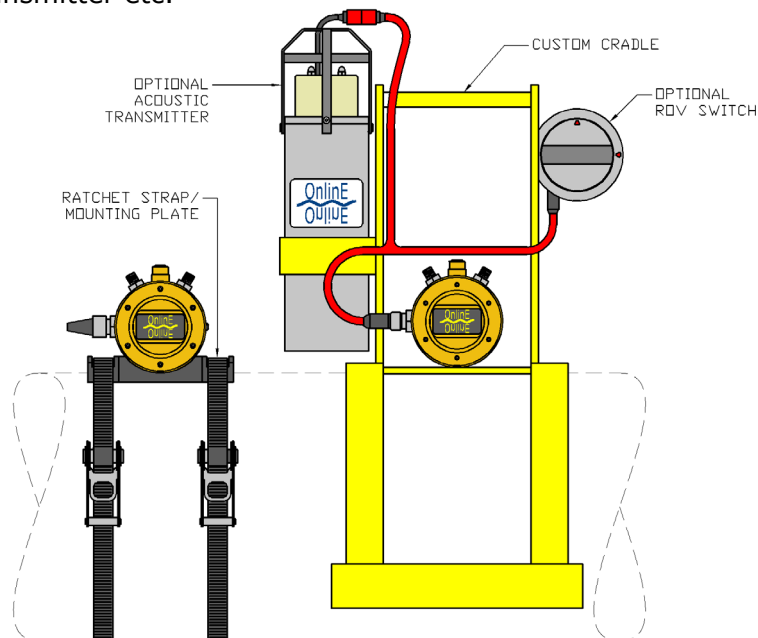

12. MAINTENANCE

NOTE 1 - IF THE EXTERNAL CONNECTOR IS UNUSED IT MUST BE FITTED WITH A SUITABLE BLANKING CONNECTOR (e.g. Burton 5501-1508-0000) TO PREVENT CONDUCTION BETWEEN THE PINS AND MALFUNCTION.

NOTE 2 - ALWAYS LOOSEN THE BLEEDSCREW TO RELIEVE ANY INTERNAL PRESSURE PRIOR TO OPENING.

NOTE 3 - DO NOT EXPOSE TO AGGRESSIVE SOLVENTS OR CHEMICALS WHICH COULD BE HARMFUL TO THE HOUSING, NITRILE RUBBER O-RINGS, THE ACRYLIC WINDOW, OR CONNECTORS.

NOTE 4 - OPENING OF THE UNIT SHOULD ONLY TAKE PLACE IN A CLEAN, DRY, LABORATORY ENVIRONMENT.

NOTE 5 - TO PREVENT THE FORMATION OF CONDENSATION WITHIN THE UNIT ALLOW THE UNIT TO STABILISE WITHIN THE LABORATORY ENVIRONMENT FOR A MINIMUM OF 6 HOURS PRIOR TO OPENING.

12.1. O-RING REPLACEMENT

The product uses the following O-rings:

1x 50-008 groove in piston bleedscrew O-ring.

2x 50-243 groove in piston endcap O-rings with 2x 250-243 PTFE Back Up Rings.

1x 50-236 groove in flange window O-ring / 1x 50-237 groove in piston window O-ring.

Ensure the free space at the tails of the spiral back up rings are filled with silicone grease and then apply a layer of grease over the seams to secure them in place. The spiral tails should not protrude from the assembly.

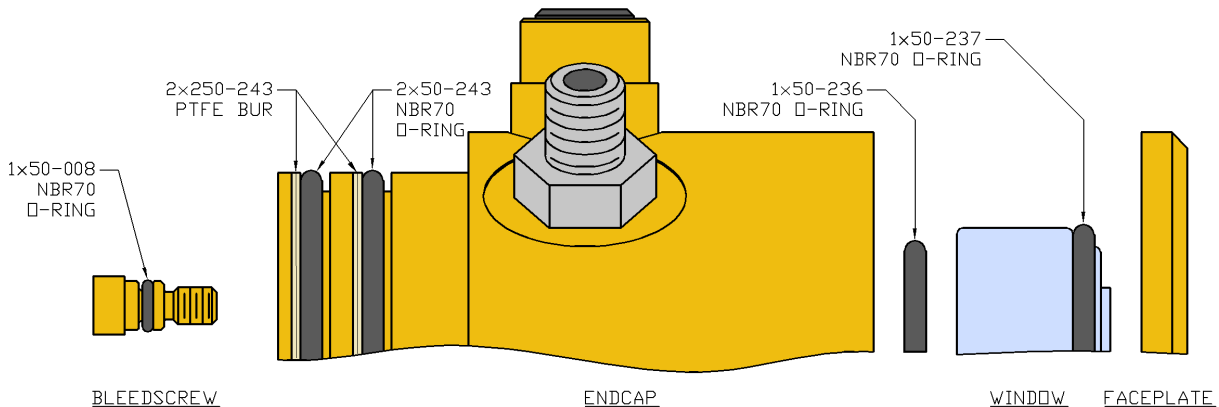

12.2. SUBSEA CABLES / CONNECTORS

Subsea connectors require regular cleaning and lubrication to ensure that contacts are clean, electrically isolated from each other and to prevent water intrusion when submerged. Before every deployment all subsea connectors and cables should be visually inspected for any visible signs of cable sheath damage, crush damage, bending damage, poorly mated or misaligned connectors etc. Seal all unused connectors with appropriate blanking caps or plugs to prevent water ingress and corrosion. Every time a connector is unmated and at least every 6 months all connectors should be inspected as follows:

1. Disconnect the connector without pulling on the cable and with no rocking or twisting motions.
2. Inspect both mating halves of the connector. Check that all connector contacts are free of any accumulation of chemical deposits, saltwater, sand, mud or other debris and that all contacts are undamaged and aligned properly.
3. Accumulation of debris or corrosion should first be removed with fresh water and a brush where required, then cleaned with a suitable contact cleaner and lubricant. Do not use chemicals which could damage the connector rubber such as WD40. Any O-rings must be inspected and if marked or damaged they must be replaced.
4. When mating connectors, lubricate the connector interfaces with Molykote 111 compound (or Silicone grease) sparingly. The two halves should be pushed squarely together with no rocking or twisting motions. If the connectors have to be forced together then something is probably wrong. Do not use the locking sleeve to pull or force the connectors together. Do not over tighten the locking sleeve as this can deform the contact alignment. Locking sleeves should be tightened firmly by hand only, when the connector is subsea the water pressure will hold the connections tightly together.

12.3. ROUTINE MAINTENANCE AND STORAGE

All IK Trax products are designed to require minimum maintenance. The housing should be cleaned using fresh water and cleaning agents as necessary. Do not use chemicals which could be damaging to the housing, the nitrile rubber O-rings, the acrylic window, or any connectors.

The 6001SD contains a coin cell (BR2032) used to permanently power the Real Time Clock circuitry which stores the date and time as well as other system variables such as LOW POWER mode while the unit is turned OFF. This battery should be replaced every 5 years at IK Trax premises.

If the unit is to be placed in storage for a long period of time ensure the unit has been cleaned and disconnect the main battery.

13. DISPOSAL OF UNIT

IK Trax takes its responsibilities under the WEEE Regulations extremely seriously and has taken steps to be compliant in line with our corporate and social responsibilities. In the UK, IK Trax has joined a registered compliance scheme WeeeCare (registration number **WEE/MP3538PZ/SCH**).

Electrical and electronic equipment should never be disposed of with general waste but must be separately collected for the proper treatment and recovery.

The crossed out bin symbol, placed on the product, reminds you of the need to dispose of it correctly at the end of its life.

When buying a new product you will have the possibility to return, free of charge, another end of life product of equivalent type that has fulfilled the same functions as the supplied equipment.

These items may be deposited at:

Online Electronics Ltd
doing business as IK Trax
Blackburn Business Park
Woodburn Road
Aberdeen
AB21 0PS
UK

Alternatively, to arrange a collection of any waste electrical equipment, obligated to Ik Trax please telephone WeeeCare on **0844 800 2004**.

14. WARRANTY

IK Trax products are guaranteed for one year from the date of purchase. Goods should be returned transportation prepaid to IK Trax, Blackburn Business Park, Woodburn Road, Aberdeen.

There is no charge for parts or labour should any product require repair due to a manufacturing deficiency during the guarantee period.

In the event of a manufacturing deficiency the inward transportation costs will be repaid to the client.